

NON-LOOSE UNKNOTS, OVERTWISTED DISCS, AND THE CONTACT MAPPING CLASS GROUP OF S^3

T. VOGEL

ABSTRACT. We classify Legendrian unknots in overtwisted contact structures on S^3 . In particular, we show that up to contact isotopy for every pair $(n, \pm(n-1))$ with $n > 0$ there are exactly two oriented non-loose Legendrian unknots in S^3 with Thurston-Bennequin invariant n and rotation number $\pm(n-1)$. (Only one overtwisted contact structure on S^3 admits a non-loose unknot K and the classical invariants have to be $\text{tb}(K) = n$ and $\text{rot}(K) = \pm(n-1)$ for $n > 1$.)

This can be used to prove two results attributed to Y. Chekanov: The first implies that the contact mapping class group of an overtwisted contact structure on S^3 depends on the contact structure. The second result is that the identity component of the contactomorphism group of an overtwisted contact structure on S^3 does not always act transitively on the set of boundaries of overtwisted discs.

1. INTRODUCTION

In 3-dimensional contact topology there is a fundamental dichotomy between tight and overtwisted contact structures pioneered by D. Bennequin [Be] and developed further by Y. Eliashberg [El92].

Usually, the attention is restricted to tight contact structures. These contact structures are characterized by the absence of so-called overtwisted discs. This is because a theorem of Y. Eliashberg implies, among other things, that the classification of contact structures on a fixed closed 3-manifold up to diffeomorphism which contain an overtwisted disc coincides with the classification of plane fields up to homotopy. Nevertheless, as is shown in this paper, there are rigidity phenomena for overtwisted contact structures.

What is important in Eliashberg's result is that one needs to control an overtwisted disc. In particular, if one considers the isotopy problem for a pair of Legendrian or transverse links, then Eliashberg's theorem can be applied effectively when the complement of the links is overtwisted.

This is not always the case. As K. Dymara noted in [Dy01], it may happen that a Legendrian or transverse knot has a tight complement. In other words it intersects all overtwisted discs. A knot with this property is called non-loose. Also, it may happen that two Legendrian knots have the same classical invariants (the Thurston-Bennequin invariant and the rotation number), each knot has an overtwisted complement but the complement of the union of the two knots is tight. In these situations one cannot apply Eliashberg's theorem directly to construct for example Legendrian isotopies between two non-loose Legendrian knots with the same classical invariants.

In her preprint [Dy04] K. Dymara gives several examples of non-loose Legendrian knots in S^3 . More examples were constructed by J. Etnyre [Et08]. He also

found examples of pairs of non-loose Legendrian knots whose complements are not diffeomorphic.

Non-loose Legendrian knots are interesting because one can obtain interesting tight contact structures from surgeries on non-loose Legendrian knots. Furthermore, as shown in this paper, non-loose unknots can be used to obtain non-trivial information about overtwisted contact structures.

The coarse classification (i.e. up to diffeomorphism) of non-loose unknots in S^3 is due to Y. Eliashberg and M. Fraser in [EIF09] and independently to J. Etnyre (see [Et13]). It turns out that on S^3 there is a unique contact structure which admits a non-loose unknot, we denote it by ξ_{-1} . As a plane field this contact structure is homotopic to the unique negative tight contact structure. Moreover, the Thurston-Bennequin number of a non-loose unknot has to be positive. Non-loose unknots with Thurston-Bennequin invariant one are called minimal.

One main result of this paper is the classification of non-loose Legendrian unknots in S^3 up to Legendrian isotopy.

Theorem 4.6. *Let $K \subset S^3$ be a non-loose Legendrian unknot with $\text{tb}(K) = n > 0$ and $\text{rot}(K) = \pm(n - 1)$. Then K is isotopic to exactly one of two standard unknots with the same classical invariants.*

The most important case is the study of the minimal case, i.e. $n = 1$. The arguments used to prove the theorem in this case rely on

- Eliashberg’s classification theorem [El89], and
- a study of the characteristic foliation on families of spheres using the techniques developed in the beautiful paper [Gi00] by E. Giroux.

Figure 1 summarizes the classification of Legendrian unknots in (S^3, ξ_{-1}) up to Legendrian isotopy. This is the combination of Theorem 4.6, Proposition 4.7 with Proposition 4.11 from [EIF09]. It turns out that Legendrian unknots (loose or non-loose) with non-negative Thurston-Bennequin number are never classified by their classical invariants.

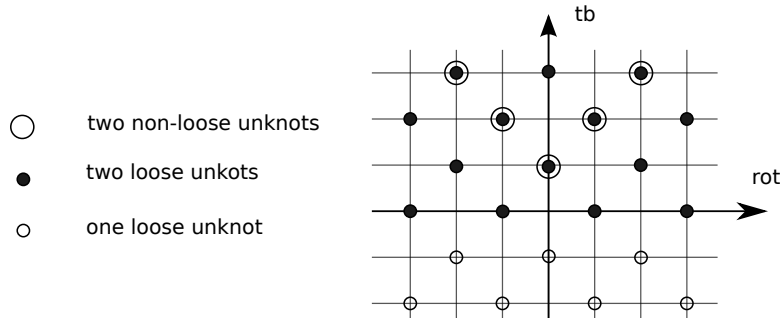

FIGURE 1. Summary of the classification of Legendrian unknots in (S^3, ξ_{-1}) up to Legendrian isotopy.

For all other contact structures on S^3 , two Legendrian unknots with the same classical invariants are Legendrian isotopic. This is stated as Proposition 4.8 in the case of overtwisted contact structures. The tight case is the subject of [EIF98, EIF09]. J. Etnyre has shown that transverse unknots are classified up to isotopy by their self-linking number (Cor. 2.3 in [Et13]). In particular, there are no non-loose transverse unknots in S^3 .

There are several applications of the classification of minimal non-loose Legendrian unknots up to isotopy: First, we prove that there is a pair of boundaries of overtwisted discs in (S^3, ξ_{-1}) which are not Legendrian isotopic to each other. More precisely, it is not always possible to find a contact isotopy in a contact manifold which moves an overtwisted ball into another such ball.

Another application concerns the contact mapping class group $\pi_0(\text{Cont}_+(S^3, \xi))$ of contact structures on S^3 which preserve the orientation of the contact structure. The following theorem is attributed to Y. Chekanov in [EIF98] without any indication of proof.

Theorem 4.4 (Chekanov). *Let ξ be an overtwisted contact structure on S^3 and denote by $\text{Diff}_+(S^3, \xi)$ the group of diffeomorphisms of S^3 which preserve ξ and an orientation of this plane field. Then*

$$\pi_0(\text{Diff}_+(S^3, \xi)) = \begin{cases} \mathbb{Z}_2 \oplus \mathbb{Z}_2 & \text{if } \xi \simeq \xi_{-1} \\ \mathbb{Z}_2 & \text{otherwise.} \end{cases}$$

The additional \mathbb{Z}_2 -summand in the case $\xi \simeq \xi_{-1}$ is determined by considering the action of contactomorphisms on isotopy classes of oriented minimal non-loose Legendrian unknots. In [Dy01] K. Dymara introduced an invariant which detects the other \mathbb{Z}_2 -factor for all overtwisted contact structures on S^3 . Finally, recall that the group of diffeomorphisms preserving the oriented tight contact structure on S^3 is connected according to [EI92].

Theorem 4.4 can be applied to obtain the classification of Legendrian links (loose and non-loose) in overtwisted contact structures once the classification up to contact diffeomorphism is known. The simplest case is of course the unknot mentioned above.

An important aspect of the classification of non-loose unknots in S^3 , that is left open in this article, is the following problem.

Problem. *Let K, K' be Legendrian unknots in (S^3, ξ_{-1}) with $\text{tb}(K) = \text{tb}(K') = n > 0$ and the same rotation number which are not isotopic to each other and both loose or both non-loose.*

If L is yet another Legendrian knot with the same properties, determine whether L is isotopic to K or to K' .

More problems can be found in [Et13] and [BaO]. Etnyre's article also contains proofs of most of the previously known results on non-loose knots. Also, the problem list [EtN] states several questions concerning Legendrian knots in overtwisted contact structures and the structure of the contact mapping class group (in particular the items 31,32, 38(4) and 40). In [BaO], K. Baker and S. Onaran propose to quantify the degree of non-looseness of Legendrian/transverse knots and suggest a number of problems related to their invariants. A coarse classification of certain rationally null-homologous knots in lens spaces was obtained by H. Geiges and S. Onaran [GeO]. Another reference is [LOSS] where the authors give an example of a pair of non-loose transverse knots with the same classical invariants which are not isotopic.

Organization of the paper: Section 2 contains definitions and examples of non-loose knots. In Section 3 we first review the coarse classification using the approach taken in [EIF09] because the normal form for the characteristic foliation on a disc bounding a non-loose unknot is used in the next sections. After the construction of

examples of contact diffeomorphisms preserving a particular non-loose unknot, we prove that every minimal non-loose unknot is isotopic to a standard example $K \subset (S^3, \xi_{-1})$. Then we show that K and \overline{K} are not isotopic as oriented knots (here we \overline{K} is K with the orientation reversed). Finally, in Section 4 we discuss Chekanov's theorem and classify Legendrian unknots in overtwisted contact structures on S^3 .

Acknowledgments: The first time I heard about non-loose knots was in discussions with J. Etnyre during which he developed a surgery based proof of the coarse classification of non-loose unknots, and I thank him for his explanations. Others, in particular Y. Eliashberg, H. Geiges, R. Gompf, P. Massot and S. Onaran, have discussed the problem with me, and I want to thank all of them. It is a great pleasure for me to thank the Mittag-Leffler Institute (and the organizers T. Ekholm, Y. Eliashberg) for organizing a program on symplectic topology in the fall of 2015 where a portion of this manuscript was prepared.

The referees provided valuable suggestions which helped to improve the presentation. In addition, one of the referees proposed that one should try to classify loose Legendrian unknots in S^3 . This classification is the content of Proposition 4.7. I want to thank both referees for their thorough and thoughtful comments.

2. PRELIMINARIES

In this section we review standard definitions and Giroux's method to describe description of contact structures in terms of families of characteristic foliations. We also explain basic facts about non-loose knots and some examples. Finally, in Section 2.6 we discuss a topological invariant introduced by K. Dymara in [Dy01] which can be used to show that the group of diffeomorphisms preserving an oriented overtwisted contact structure on S^3 is not connected.

2.1. Tight and overtwisted contact structures.

Definition 2.1. A *contact structure* is a smooth plane field ξ on a 3-manifold which is locally defined by a 1-form α such that $\alpha \wedge d\alpha$ never vanishes.

Manifolds admitting contact structures are necessarily oriented, and we will only consider cooriented contact structures which are positive (i.e. $\alpha \wedge d\alpha > 0$). Throughout this paper, we assume that ξ is oriented as a plane field.

An important fact which we will use is Gray's theorem:

Theorem 2.2. *Let ξ_t be a family of contact structures on a closed 3-manifold. Then there is an isotopy ψ_t such that $\psi_{t*}(\xi_0) = \xi_t$.*

Parametric and relative versions of this theorem also hold. One refinement which comes out of the proof of Theorem 2.2 by the Moser method is the following: If K is a Legendrian knot which is tangent to ξ_t for all t , then ψ_t can be chosen to preserve K (but not pointwise, of course). The details can be found in Section 2.2 of [Ge], for example.

Definition 2.3. An embedded disc $D \rightarrow M$ in a contact manifold (M, ξ) is *overtwisted* if $T_p D = \xi(p)$ for all points $p \in \partial D$. A contact structure is *tight* if there is no overtwisted disc, otherwise it is *overtwisted*.

The following two theorems of Eliashberg highlight the fundamental difference between overtwisted contact structures (which are very flexible) and tight ones (for which more rigidity phenomena appear).

Theorem 2.4 (Eliashberg [El92]). *Let ξ be the germ of a tight contact structure along ∂B^3 . The space of tight contact structures on the ball which coincide with ξ near ∂B^3 is weakly contractible.*

In particular, the relative homotopy type of the plane field on $(B^3, \partial B^3)$ is completely determined by the boundary data and the requirement that ξ is a tight contact structure.

Now let ξ_Δ be a contact structure defined near a disc Δ and on a neighborhood of a compact set N so that Δ is an overtwisted disc for ξ_Δ . We will use the following notation:

$$\begin{aligned} \text{Cont}(M, N, \xi_\Delta) &= \{\text{contact structures equal to } \xi_\Delta \text{ near } \Delta \cup N\} \\ \text{Distr}(M, N, \xi_\Delta) &= \{\text{plane fields which coincide with } \xi_\Delta \text{ near } \Delta \cup N\}. \end{aligned}$$

Both spaces carry the C^k -topology with $k \geq 1$. The proof of the following theorem can be found in [El89]. It is discussed also in [Gi93, Ey] and [Ge]. Y. Huang proved a non-parametric version using bypasses in [Hu13].

Theorem 2.5 (Eliashberg [El89]). *Let ξ_Δ be a contact structure as above and $N \subset M$ a compact set in the complement of Δ such that $M \setminus N$ is connected. Then*

$$\text{Cont}(M, N, \xi_\Delta) \leftrightarrow \text{Distr}(M, N, \xi_\Delta)$$

is a weak homotopy equivalence.

The statement can be enhanced even further: Not only does a relative version with respect to compact subsets N of M hold, but also a relative version with respect to compact subsets of the parameter space. More precisely, if $\zeta_s, s \in S$, is a family of plane fields in $\text{Distr}(M, N, \xi_\Delta)$ with compact parameter space S and $S' \subset S$ is a compact set such that $\zeta_s \in \text{Cont}(M, N, \xi_\Delta)$ for $s \in S'$, then one does not have to change ζ_s for $s \in S'$ when applying Theorem 2.5.

Given two disjoint overtwisted discs Δ_1 and Δ_2 one can combine the two relative versions and obtain a family of contact structure from a family $\zeta_s, s \in [0, 1]$, such that Δ_1 , respectively Δ_2 , are overtwisted discs of ζ_s when $s \in [0, 2/3]$ respectively $[1/3, 1]$.

Also, assume that for a family of plane fields $\zeta_s, s \in [0, 1]$, there is a family of overtwisted discs Δ_s contained in the region where ζ_s is a positive contact structure and an isotopy φ_s such that $\Delta_s = \varphi_s(\Delta_0)$. Then one can apply Theorem 2.5 to $(\varphi_s^{-1})_*(\zeta_s)$ to obtain a deformation of ζ_s to a family of contact structures ξ_s such that Δ_s is an overtwisted disc of ξ_s .

Theorem 2.5 can be used to produce families of overtwisted contact structures on S^3 with prescribed homotopy type as families of plane fields. The following consequence of Theorem 2.5 can be found [Dy01].

Lemma 2.6. *Let ξ be a contact structure on a collar N of the boundary of B^3 which is overtwisted. For every relative homotopy class of families of plane fields $\zeta_s, s \in K$, where K is a compact manifold, which coincides with ξ on N there is a family of contact structures ξ_s in the same homotopy class.*

Proof. This is a direct application of Theorem 2.5: By assumption, there is always a fixed overtwisted disc in N , so every family of plane fields $\zeta_s, s \in K$, as in the lemma on B^3 can be homotoped to a family of contact structures $\xi_s, s \in K$. \square

Before we discuss Legendrian and transverse knots, let us note one consequence of Theorem 2.4. The arcs γ_0, γ_1 appearing in the second part of the proposition will be open segments of Legendrian knots in later applications.

Proposition 2.7 (V. Colin, [Co99]). *Let $B_0, B_1 \subset M$ be two closed balls in a contact manifold such that $B_0 \subset B_1$ and the contact structure is tight on an open neighborhood V of B_1 . Then there is a contact isotopy of M with support in V which moves B_1 into the interior of B_0 .*

If there is a pair of unknotted open Legendrian arcs γ_0, γ_1 which are transverse to ∂B_0 and ∂B_1 each arc intersects ∂B_0 and ∂B_1 exactly once, then one can choose the isotopy so that it preserves γ_0, γ_1 .

Definition 2.8. A Legendrian knot in a contact manifold (M, ξ) is an embedding $S^1 \rightarrow M$ so that the tangent space of the image is contained in ξ . A knot K in (M, ξ) is *transverse* if its tangent space is transverse to $\xi(p)$ at every point $p \in K$, usually a transverse knot is oriented so that the orientation coincides with the coorientation of ξ .

In addition to their isotopy type as embedded curves, null-homologous Legendrian or transverse knots have the following classical invariants.

Definition 2.9. Let Σ be a connected Seifert surface for a Legendrian knot K . The *Thurston-Bennequin invariant* $\text{tb}(K)$ of K is the algebraic intersection number of the push off of K along a vector field transverse to ξ with Σ . The *rotation number* $\text{rot}(K)$ of K is the number of full turns the positive tangent vector of K makes compared to an oriented framing of $\xi|_{\Sigma}$ (Σ is a surface with boundary) as one moves along the oriented curve K .

The *self-linking number* $\text{sl}(K)$ of a null-homologous transverse knot K is the algebraic intersection number of a Seifert surface Σ with K' where K' is obtained from K by pushing K away from itself using a vector field tangent to ξ which vanishes nowhere along Σ .

In general, these invariants depend on the choice of $[\Sigma] \in H_2(M, K; \mathbb{Z})$, but if $M = S^3$, then the Thurston-Bennequin invariant, the rotation number and the self-linking number are independent of the Seifert surface Σ . Note that tb is also independent of the orientation of the knot while the rotation number changes sign when the orientation of K is reversed.

For an oriented Legendrian knot K one obtains a transverse knot by pushing K away from itself using a vector field N tangent to ξ so that along the knot the vector field N followed by the tangent direction of K is an oriented basis of ξ . The resulting knot will be denoted by K^+ and according to [Be] the classical invariants of K and K^+ are related as follows

$$(1) \quad \text{sl}(K^+) = \text{tb}(K) - \text{rot}(K).$$

Theorem 2.10 (Eliashberg [El92]). *Let (M, ξ) be a contact 3-manifold. Then ξ is tight if and only if*

$$(2) \quad \text{tb}(K) + |\text{rot}(K)| \leq -\chi(\Sigma)$$

for every null-homologous Legendrian knot K and Seifert surface Σ . This is equivalent to

$$(3) \quad \text{sl}(K) \leq -\chi(\Sigma)$$

for every transverse knot with Seifert surface Σ .

Finally, we note that a Legendrian knot can be stabilized to another Legendrian knot in the same smooth knot type such that the Thurston-Bennequin invariant decreases by 1 and the rotation number changes by ± 1 . Depending on the sign the stabilization is said to be positive or negative (a negative stabilization appears in Figure 6 on p. 17). The stabilized knot is well-defined up to Legendrian isotopy and if two Legendrian knots are isotopic, then the same is true for their positive (or negative) stabilizations.

2.2. Surfaces in contact manifolds. Let Σ be an oriented surface embedded in a contact manifold (M, ξ) . If $\partial\Sigma \neq \emptyset$, then we require that the boundary is tangent to ξ . The following terminology introduced in [Gi91] for contact structures will be used for general plane fields (in this context we will often use the notation ζ instead of ξ).

Definition 2.11. The *characteristic foliation* $\xi(\Sigma)$ on Σ is defined by the singular line field $T\Sigma \cap \xi$. The characteristic foliation is oriented so that the orientation of $\xi(\Sigma)$ followed by the coorientation of ξ is the orientation of Σ .

A point $p \in \Sigma$ is called *singular* if $T_p\Sigma = \xi(p)$, when ξ and Σ are oriented, a singular point is *positive* if the orientations coincide, otherwise it is *negative*.

The characteristic foliation on a closed surface Σ determines the germ of ξ along Σ up to isotopy preserving $\xi(\Sigma)$.

For singular points there is a well-defined notion of positive/negative divergence. Positive singularities have positive divergence while the divergence at negative singularities is negative. The orientation convention turns positive/negative elliptic singularities into sources/sinks.

Because of the contact condition, the characteristic foliation near an isolated singular point has a particular form. For example, the index of such a critical point can only be ± 1 or 0 (a proof can be found in [V]).

Generically, the singular line field $\xi(\Sigma)$ on Σ defines a Morse-Smale foliation, i.e.

- all singularities are non-degenerate,
- all closed orbits are hyperbolic, and
- there are no connections between hyperbolic singularities.

Giroux [Gi91] has proved that these properties together imply that Σ is there is a contact vector field which is transverse to Σ .

Definition 2.12. An embedded surface with Legendrian boundary in a contact manifold is *convex* if there is a contact vector field transverse to Σ .

Of course, the characteristic foliation does not have to be Morse-Smale to be convex. For example, connections between hyperbolic singularities of the same sign never prevent convexity.

Giroux has found a topological property of the characteristic foliation on Σ which determines whether Σ is convex or not.

Definition 2.13. A collection Γ of curves and properly embedded arcs on a surface Σ with $\partial\Gamma \subset \partial\Sigma$ *divides* a singular foliation if

- (i) Γ is transverse to $\xi(\Sigma)$ and Γ decomposes Σ into two subsurfaces Σ_+, Σ_- (not necessarily connected), and

- (ii) there is a vector field X directing $\xi(\Sigma)$ and an area form ω on Σ such that $L_X\omega > 0$, respectively $L_X\omega < 0$, on the interior of Σ_+ , respectively Σ_- , and X is pointing out of Σ_+ .

Theorem 2.14 (Giroux [Gi91]). *An oriented compact surface $\Sigma \subset (M, \xi)$ with Legendrian boundary is convex if and only if $\xi(\Sigma)$ admits a dividing set. The dividing set is unique up to isotopy through multicurves transverse to the characteristic foliation.*

A convex surface in a contact manifold has a neighborhood where ξ is tight if and only if either

- $\Sigma \simeq S^2$ and $\xi(\Sigma)$ has a connected dividing set, or
- $\Sigma \not\simeq S^2$ and no component of a dividing set of $\xi(\Sigma)$ bounds a disc.

If one of these two conditions in the theorem are violated for a convex surface, we will say that this surface contains an obvious overtwisted disc.

Because of the Poincaré-Bendixson theorem, it is easier to describe the necessary and sufficient conditions on $\xi(\Sigma)$ for Σ to be convex when $\Sigma \simeq S^2$. Recall that $\xi(\Sigma)$ is oriented, so we may think of the leaves of $\xi(\Sigma)$ as flow lines of a vector field.

Lemma 2.15. *An embedded sphere S^2 in a contact manifold (M, ξ) whose characteristic foliation has only isolated singularities is convex if and only if*

- each closed leaf of $\xi(S^2)$ is hyperbolic, and
- there is no connection from a negative singular point to a positive singular point.

Proof. If Σ is convex and Γ is a dividing set, then all positive singularities are contained in Σ_+ while the negative singularities lie in Σ_- . Also, a closed leaf is hyperbolic if and only if there is a couple (X, ω) as in Definition 2.13 on a neighborhood of the closed leaf. Thus, in order to be convex, (i) and (ii) have to be satisfied.

For the opposite direction, recall that by the Poincaré-Bendixson theorem all limit sets of leaves of $\xi(\Sigma)$ are either closed leaves or cycles formed by finitely many leaves of $\xi(\Sigma)$ which connect singular points. Therefore, if a characteristic foliation on S^2 satisfies (i) and (ii) then one can construct a triple (X, ω, Γ) as in the proof of Proposition 2.6 of [Gi91]. \square

There are effective methods to manipulate the characteristic foliation on a surface, in particular when the surface is convex (see [Gi91] and Theorem 3.7 in [Ho]). The following lemma can also be found in [Gi91] and does not require convexity.

Lemma 2.16. *Let $\Sigma \subset (M, \xi)$ be an embedded surface such that the characteristic foliation has a leaf γ connecting two singular points with the same sign such that the index of one of the singularities is 1 while the other has index -1 .*

Then Σ can be isotoped on a neighborhood of γ such that these two singular points disappear from the characteristic foliation on the isotoped surface and γ remains Legendrian while no new singular points appear.

A more precise/complicated version of this is Lemma 2.22 below. Conversely, one can also create a pair of singularities as in Lemma 2.16.

There is another possible modification which is particularly relevant when considering surfaces with Legendrian boundary. The modification shown in Figure 2

preserves the boundary of a surface (represented by the thickened horizontal line), it is explained in Lemma 2.2 of [EIF09]. Note that if the hyperbolic point is positive, respectively negative, then its unstable leaves, respectively its stable leaves, have to be part of the boundary.

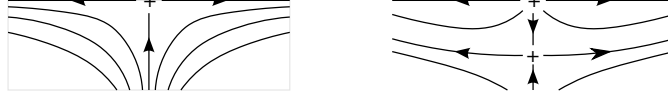

FIGURE 2. Splitting hyperbolic points on a Legendrian boundary of a surface

Finally, we note that the rotation number of a Legendrian knot K with Seifert surface Σ can be computed from $\xi(\Sigma)$ assuming all singular points of $\xi(\Sigma)$ are isolated. Let e_{\pm} , respectively h_{\pm} , be the number of singular points of index $+1$, respectively -1 , whose sign is \pm in the interior of Σ . If the singularities on the boundary are all either hyperbolic or all elliptic, then according to [Et05]

$$(4) \quad \text{rot}(K) = e_+ - e_- - h_+ + h_-.$$

2.3. Tomographie. If ξ is a contact structure on $\Sigma \times [-1, 1]$, then one can study the family $\xi(\Sigma \times \{t\})$, $t \in [-1, 1]$ of characteristic foliations. This approach is pursued by E. Giroux in [Gi00], an exposition of some aspects of this can be found in [Ge]. We recall some results from [Gi00] in this section. An important application of Giroux's study is a proof of Bennequin's theorem.

Theorem 2.17 (Bennequin). *A contact structure on $S^2 \times [-1, 1]$ such that every sphere of the product decomposition is convex and has connected dividing set is tight.*

2.3.1. Movies of characteristic foliations. Let $\Sigma \times [-\delta, \delta]$, $\delta > 0$, be the closure of a tubular neighborhood of an oriented surface in a contact manifold (M, ξ) . We assume that Σ is compact and $\partial\Sigma \times \{t\}$ is Legendrian for all $t \in [-\delta, \delta]$.

Definition 2.18. The *movie* of ξ on $\Sigma \times [-\delta, \delta]$ is the family of characteristic foliations of ξ on $\Sigma \times \{t\} = \Sigma_t$, $t \in [-\delta, \delta]$.

According to [Gi00] (see also [Ge]) the movie determines the contact structure up to isotopy. Conversely, not every movie of singular foliations arises as movie of a contact structure: If ξ is a contact structure and $\xi(\Sigma_0)$ violates one of the conditions (i),(ii) of Lemma 2.15, then this has consequences for $\xi(\Sigma_t)$ for t close to 0. The following definitions and lemmas are due to E. Giroux [Gi00].

Definition 2.19. A *retrogradient connection* is a leaf connecting a positive singular point with a negative one such that the leaf is oriented towards the positive singularity. A retrogradient connection is *non-degenerate* if both endpoints are non-degenerate singular points.

The following two lemmas are key for the understanding of non-convex spheres in contact manifolds:

Lemma 2.20 (Lemme de croisement, 2.14 in [Gi00]). *Let ξ be an oriented positive contact structure on $\Sigma \times (-1, 1)$ such that there is a non-degenerate retrogradient connection in $\xi(\Sigma_0)$. For $t > 0$, respectively $t < 0$, the corresponding stable leaf in $\xi(\Sigma_0)$ lies over, respectively under, the corresponding unstable leaf.*

Here and in the next lemma, the words over and under refer to the coorientation of ξ .

Lemma 2.21 (Lemme de naissance-mort, 2.12 in [Gi00]). *Let γ be a closed leaf of the characteristic foliation on $\xi(\Sigma_0)$ which is attractive on one side and repelling on the other. If the repelling side lies above γ , then for $t > 0$ small enough $\xi(\Sigma_t)$ has two non-degenerate closed orbits in a neighborhood of γ while this neighborhood contains no closed leaves for $t < 0$. If the repelling side is below γ , then it is the other way round.*

These lemmas provide criteria to determine when a movie coming from a plane field cannot be the movie of a contact structure.

The elimination lemma (Lemma 2.16) admits a generalization where the surface $\Sigma \times \{0\}$ is part of a movie. It takes into account how the elimination affects the characteristic foliation on nearby surfaces of the movie. We state a simplified version of Lemma 2.15 [Gi00] which suffices for the applications in this paper.

The setup for the lemma is as follows: Let ξ be a contact structure on $\Sigma \times [-1, 1]$ such that $\xi(\Sigma_0)$ has an elliptic point a_0 and a hyperbolic point b_0 of the same sign (we assume positive) and a separatrix γ_0 of b_0 connects b_0 to a_0 . This is a stable configuration, i.e. there is $0 < \delta < 1$ and a smooth family a_t, b_t of singular points connected by a leaf γ_t of $\xi(\Sigma_t)$, $t \in [-\delta, \delta]$. Let U be a neighborhood of $\cup_{t \in [-\delta, \delta]} \gamma_t$. We abbreviate $U_t = U \cap \Sigma_t$ and use G_t to denote the closure of the union of closed segments of leaves of $\xi(\Sigma_t)$ both of whose endpoints lie in U_t .

Lemma 2.22 (Lemme d'élimination, Lemma 2.15 in [Gi00]). *In this situation, there is a deformation of ξ through contact structures with support in U such that after the deformation U_t contains no singular points of the characteristic foliation for $t \in (-\delta, \delta)$.*

Moreover, let $\Lambda \subset (-\delta, \delta)$ be compact and assume that for all $t \in \Lambda$ there is a defining 1-form for the characteristic foliation on Σ_t whose differential does not vanish on G_t .

Then the deformation can be chosen such that every surface $\Sigma_t, t \in \Lambda$ which

- *was convex before the deformation, and*
- *admits a dividing set disjoint from U_t*

remains convex after the deformation.

Recall that by Gray's theorem a deformation of ξ through contact structures keeping the product structure on $\Sigma \times [-1, 1]$ fixed can be viewed as a deformation of the product structure keeping ξ fixed and vice versa.

A simple application of Lemma 2.22 shows that a single retrogradient connection appearing in a movie of a contact structure on $S^2 \times [-1, 1]$ which is not obviously overtwisted (i.e. no overtwisted disc is present on one of the leaves) is tight.

Lemma 2.23. *Let ξ be a contact structure on $N \simeq S^2 \times [-1, 1]$ (with a generic product decomposition) which is tight near the boundary such that the characteristic foliation on S_t^2 is convex except when $t = 0$ and the characteristic foliation on S_0^2 has exactly one retrogradient connection between hyperbolic points.*

Then ξ is isotopic to a family of contact structures on $S^2 \times [-1, 1]$ such that all spheres S_t^2 are convex and ξ is tight.

Proof. Because we assume that the product decomposition is generic, all singular points of $\xi(\Sigma_0)$ are non-degenerate. We pick $\varepsilon_0 > 0$ so that this is the case for $\xi(\Sigma_t)$ for $|t| \leq \varepsilon_0$.

Let Γ_t^- be the graph whose vertices are negative singularities and whose edges are unstable leaves of negative singularities. For $t \neq 0$ this is a connected tree because ξ is tight on $S^2 \times [-1, 0)$ and $S^2 \times (0, 1]$. The graph Γ_0^- consists of two connected components, one of these components is not closed (the ω -limit set of the edge γ forming the retrogradient saddle-saddle connection is a positive hyperbolic singularity p_+ and does not lie in Γ_0^-).

By Lemma 2.20 both unstable leaves of p_+ have their ω -limit set in the closed component of Γ_0^- , otherwise $\xi(S_t^2)$ would contain obvious overtwisted discs for $t > 0$ or $t < 0$.

Apply Lemma 2.22 to eliminate all positive hyperbolic singularities on S_t^2 for t close to 0. Since for $t \neq 0$ both stable leaves of positive hyperbolic singularities come from different elliptic singularities, one can choose U_t so that $G_t = U_t$ for $\varepsilon/2 \leq |t| \leq \varepsilon$ so that the condition on the existence of 1 forms is fulfilled and U_t is disjoint from a dividing set. In the same way, we eliminate all negative hyperbolic singularities.

We can thus arrange that for the deformed contact structure

- there are no hyperbolic points left on Σ_t for $|t| \leq \varepsilon/2$, and
- Σ_t is convex for $\varepsilon/2 \leq |t| \leq \varepsilon$.

The resulting contact structure is convex for all t . Therefore it is tight by Theorem 2.17. The same is true for the original contact structure ξ by Gray's theorem. \square

Remark 2.24. The above Lemma can be generalized to the case when $\xi(S_0^2)$ has more than one retrogradient connection as long as every connected component of the graph obtained from Γ_0^- by removing these connections contains at least as many negative elliptic points as negative hyperbolic points. In particular, if $\xi(S_0^2)$ has exactly two retrogradient connections, then ξ can either be deformed using the elimination lemma so that the resulting characteristic foliation on a disc in S_0 is homeomorphic to the one shown in the middle part of Figure 7 (on p. 24), or the retrogradient connections can be eliminated completely.

2.3.2. Movies of contact structures on $S^2 \times [-1, 1]$. Let $\xi_\sigma, \sigma \in [0, 1]$, be a family of contact structures on $S^2 \times [-1, 1]$ where the product decomposition and the contact structure vary smoothly but are constant near the boundary of $S^2 \times [-1, 1]$.

We make the following genericity assumptions on the movie of ξ_σ on $S^2 \times [-1, 1]$ with respect to product decomposition associated to the parameter value σ :

- For all parameter values σ and all $t \in [-1, 1]$, the characteristic foliation on $\xi_\sigma(S_t^2), t \in [-1, 1]$, has only finitely many singular points.
- The parameter values where $\xi_\sigma(S_t^2)$ has a simply degenerate closed orbit (i.e. the first derivative of the holonomy along the close leaf vanishes, the second derivative does not) is a union of finitely many hypersurfaces in $[-1, 1] \times [0, 1]$ which intersect transversely.
- The parameter values where $\xi_\sigma(S_t^2)$ has a doubly degenerate closed orbit (i.e. the first and the second derivative of the holonomy along the closed leaf vanishes, the third derivative does not) is a union of finitely many submanifolds of codimension 2 of $[-1, 1] \times [0, 1]$.

By Lemma 2.20 and Lemma 2.21 the submanifolds of $[-1, 1] \times [0, 1]$ associated to connections pointing from negative singularities to positive ones (i.e. retrogradient connections) or to degenerate closed leaves are never tangent to the foliation of $[-1, 1] \times [0, 1]$ given by the first factor. In particular, if the stable leaf of a positive singularity coincides with the unstable leaf of a negative singularity, then this coincidence is not degenerate.

In Section 2.I of [Gi00], E. Giroux gives a beautiful proof of Bennequin's theorem based in particular on Lemma 2.20 and Lemma 2.21.

The main step is his proof of the following claim: For a generic family of contact structures on $S^2 \times [-1, 1]$ configurations like the one shown in Figure 3 do not occur. In this figure, the t -coordinate corresponds to the horizontal direction, the vertical direction represents the parameter σ of the family. The curved lines intersecting once transversely in the box represent the locus where $\xi_\sigma(S_t^2)$ is not convex (by Lemma 2.20 and Lemma 2.21 these lines are transverse to the horizontal direction). The numbers on the complement of the non-convexity locus denote the number of connected components of the dividing set.

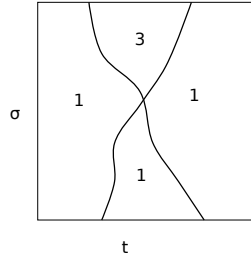

FIGURE 3. Forbidden configuration according to Giroux's proof of Bennequin's theorem

Let ξ be an overtwisted contact structure on $N = S^2 \times [-1, 1]$ which coincides with a given tight contact structure ξ_0 near the boundary. We fix a Riemannian metric on N , and we will use the C^2 -topology on the space $\text{Cont}_\partial(N, \xi_0)$ of contact structures which coincide with ξ_0 on a neighborhood of the boundary. We define $T_\pm : \text{Cont}_\partial(N, \xi_0) \rightarrow [-1, 1]$ as

$$(5) \quad \begin{aligned} T_-(\xi) &= \sup\{t \in [-1, 1] \text{ such that } \xi \text{ is tight on } S^2 \times [-1, t]\} \\ T_+(\xi) &= \inf\{t \in [-1, 1] \text{ such that } \xi_\sigma \text{ is tight on } S^2 \times (t, 1]\}. \end{aligned}$$

Since ξ is tight near the boundary, these functions take values in $(-1, 1)$.

Lemma 2.25. T_+ and T_- are continuous.

Proof. Let $\xi \in \text{Cont}_\partial(N, \xi_0)$. For all $\varepsilon > 0$ the set $S^2 \times [-1, T_-(\xi) + \varepsilon)$ contains a transverse knot violating the Thurston-Bennequin inequality (3). Therefore, there is a neighborhood of ξ such that $T_-(\xi') < T_-(\xi) + \varepsilon$ for all ξ' in that neighborhood.

For all plane fields ξ' on N there is a unique defining form α' coorienting ξ' such that $\|\alpha'\| \equiv 1$. Let α define ξ and fix a neighborhood V of ξ in the space of plane fields which coincide with ξ_0 near $\partial S^2 \times [-1, 1]$ such that for all ξ' in V the forms $\alpha_t = t\alpha' + (1-t)\alpha$, $t \in [0, 1]$, are contact.

The isotopy φ_t , obtained from the proof of Gray's theorem (such that $\varphi_1^*\alpha'$ is a multiple of α) depends continuously on ξ' . In particular, for all $\varepsilon > 0$ there

is a neighborhood U of ξ in $\text{Cont}_\partial(N, \xi_0)$ such that for all ξ' in U the image of $S^2 \times [-1, T_-(\xi) - \varepsilon]$ under the contactomorphism $\varphi_1^{-1} : (N, \xi') \rightarrow (N, \xi)$ is contained in $S^2 \times [-1, T_-(\xi))$ where ξ is tight. Therefore, $T_-(\xi') \geq T_-(\xi) - \varepsilon$ for ξ' in U .

This implies $T_-(\xi') \in [T_-(\xi) - \varepsilon, T_-(\xi) + \varepsilon]$ for all ξ' in the neighborhood $U \cap V$ of ξ . The proof for T_+ is analogous. \square

The previous lemma is true for contact structures on $\Sigma \times [-1, 1]$ for all closed oriented surfaces Σ . In contrast, the next lemma follows from Giroux's proof of Bennequin's theorem (p. [Gi00]) and is false when S^2 is replaced by an oriented surface of higher genus.

Lemma 2.26. *Let ξ be an overtwisted contact structure on $S^2 \times [-1, 1]$ such that $\xi = \xi_0$ is tight on a neighborhood of ∂N . Then $T_-(\xi) \leq T_+(\xi)$.*

Proof. Assume first that ξ is generic in the sense that all singular points are isolated and retrogradient connections occur only between non-degenerate singular points of $S^2 \times \{t\}$ for all t .

The proof of Bennequin's theorem in [Gi00] shows that if the movie of a generic contact structure on $S^2 \times [-1, 1]$ contains no obvious Legendrian knot (i.e. a loop formed by leaves of the characteristic foliation on a sphere $S^2 \times \{t\}$, $t \in (-1, 1)$) which violates the Thurston-Bennequin inequality, then the contact structure is tight.

Then, by definition, $S^2 \times \{T_+(\xi)\}$ contains an obvious Legendrian knot violating the Thurston-Bennequin inequality. Thus, for all $t > T_+(\xi)$, the contact structure ξ on $S^2 \times [-1, t]$ is overtwisted, i.e. $T_-(\xi) \leq T_+(\xi)$.

By continuity, the claim follows for all contact structures in $\text{Cont}_\partial(N, \xi_0)$. \square

2.4. Non-loose knots. We introduce the main subject of this paper, non-loose knots, and discuss some of their properties. First, recall the following theorem which follows from Theorem 2.5.

Theorem 2.27 (Dymara, [Dy01]). *Let ξ be an overtwisted contact structure on S^3 and K_0, K_1 Legendrian knots which are smoothly isotopic, $\text{tb}(K_0) = \text{tb}(K_1)$ and $\text{rot}(K_0) = \text{rot}(K_1)$. If there is an overtwisted disc Δ in the complement of $K_0 \cup K_1$, then there is a Legendrian isotopy between K_0 and K_1 , i.e. a family of Legendrian knots K_t , $t \in [0, 1]$, interpolating between K_0 and K_1 .*

It is therefore more interesting to study knots (or pairs of knots) which do not satisfy the conditions stated in Theorem 2.27.

Definition 2.28. A Legendrian or transverse knot K in an overtwisted contact manifold (M, ξ) is *loose* if ξ is overtwisted on the complement of K . Otherwise, it is *non-loose*.

The analogous terminology is used for Legendrian and transverse links. In [EIF98] non-loose knots are called exceptional.

It is relatively easy to show that every overtwisted contact structure ξ on a closed manifold M admits a non-loose transverse link. For example, the binding K of an open book of M carrying ξ is a non-loose transverse knot. Also, it is well-known that every closed contact manifold (M, ξ) can be obtained by Legendrian surgery on a link in the standard tight contact structure in S^3 . The surgery curves induce a non-loose Legendrian link in (M, ξ) .

The following modified Thurston-Bennequin inequality is one of the few general results on non-loose knots.

Theorem 2.29 (Świątkowski, [Et13]). *Let $K \subset M$ be a null-homologous Legendrian non-loose knot which is non-loose. Then*

$$(6) \quad -|\text{tb}(K)| + |\text{rot}(K)| \leq -\chi(\Sigma)$$

for every embedded surface Σ with $\partial\Sigma = K$.

Unlike the Thurston-Bennequin inequality (2) for Legendrian knots in tight contact manifolds, (6) does not yield an upper bound for the Thurston-Bennequin invariant of a non-loose knot.

Lemma 2.30 (Etnyre, [Et13]). *Let $K \subset (M, \xi)$ be a Legendrian knot in an overtwisted contact structure. If a stabilization of K is non-loose, then so is K .*

Proof. We argue by contradiction. Assume that K is loose and let K' be a stabilization of K which is non-loose. The complement of K contains an overtwisted disc Δ . But every stabilization of a Legendrian knot is isotopic to a knot contained in an arbitrarily small neighborhood of K . Thus, we can assume that K' is contained in $M \setminus \Delta$ contradicting the tightness of $M \setminus K'$. \square

Finally, there is a further restriction on the Thurston-Bennequin invariant of non-loose unknots [Dy04].

Lemma 2.31. *Let K be a non-loose Legendrian unknot in an overtwisted contact manifold (M, ξ) . Then $\text{tb}(K) > 0$.*

Proof. Since K is an unknot, it bounds a disc D . Obviously $\text{tb}(K) \neq 0$, since otherwise we could choose D to be a convex overtwisted disc by Proposition 3.1 in [Ho], and the complement of K would not be tight. Also, if $\text{tb}(K) < 0$ we can choose D to be convex, i.e. there is a tubular neighborhood $D \times [-\varepsilon, \varepsilon]$ such that the contact structure on this neighborhood is tight (because ξ is tight on the complement of K , the dividing set of D does not have a closed component). Since the contact structure on $M \setminus D = M \setminus (D \times \{0\})$ is also tight, this tubular neighborhood cannot contain an overtwisted disc. Rounding the edges of $D \times [-\varepsilon, \varepsilon]$ we find a closed ball B such that

- the contact structure on B is tight,
- the contact structure on $M \setminus B$ is tight, and
- the boundary of B is a convex surface.

According to [Co97] this implies that ξ is tight contradicting the assumption that ξ is overtwisted. \square

This lemma motivates the following terminology.

Definition 2.32. A non-loose unknot K with $\text{tb}(K) = 1$ is called *minimal*.

2.5. Examples of non-loose knots. In this section we discuss examples of non-loose Legendrian knots in S^3 . We will focus on one overtwisted contact structure which we will denote by ξ_{-1} later (sometimes we will refer to it as the *standard overtwisted contact structure* on S^3).

According to R. Lutz [Lu] S^1 -invariant contact structures on S^1 -principal bundles $\pi : M \rightarrow \Sigma$ over closed oriented surfaces are classified up to S^1 -equivariant

isotopy by the projection Γ of

$$(7) \quad \{p \in M \mid \xi(p) \text{ is tangent to the fiber through } p\}$$

to Σ . Because of the contact condition, this is an embedded submanifold of dimension 1 in the base surface. When Γ is a simple closed curve in $\Sigma = S^2$ and the Euler number of $\pi : M \rightarrow S^2$ is 1, then we obtain ξ_{-1} .

Let K be the fiber over a point of $p \in \Gamma$ and $p \neq q \in \Gamma$. A convenient way to establish the universal tightness of ξ_{-1} on the complement of K relies on techniques developed by E. Giroux in [Gi91, Gi00]: One studies the characteristic foliation of ξ_{-1} on $T_t^2 = \pi^{-1}(S_t^1)$ where $S_t^1, t \in (0, 1)$, is a family of nested circles in S^2 such that the circles S_t^1 converge to p , respectively q , as $t \rightarrow 0$, respectively $t \rightarrow 1$. We choose the circles in such a way that they are transverse to Γ and the intersection of Γ with S_t^1 consists of two points for all $t \in (0, 1)$. The fibers above these points form pairs of Legendrian curves and each of these curves is either a non-singular leaf or a line of singularities of $\xi_{-1}(T_t^2)$. One of these lines is repulsive while the other is attractive. For all $\varepsilon > 0$ the sheet (this is our translation of the french word *feuille* used in [Gi00]) of the movie of characteristic foliations on $T_t^2, t \in [\varepsilon, 1)$, becomes an annulus after we add the Legendrian curve $\pi^{-1}(q)$ to $T_t^2, t \in (0, 1)$ (adding this curve to $\cup_{t \in [\varepsilon, 1)} T_t^2$ one obtains a solid torus).

According to [Gi00] (Section 4.B) up to isotopy there is a unique contact structure on the solid torus which has a movie with the properties described above. This contact structure is universally tight for all $\varepsilon \in (0, 1)$, i.e. ξ_{-1} is universally tight on the complement of K .

Alternatively, one can also show that ξ_{-1} is universally tight on $S^3 \setminus K$ by embedding the universal cover of $S^3 \setminus K$ into \mathbb{R}^3 with the standard contact structure. This is the approach taken by K. Dymara in [Dy01, Dy04].

From the above description of ξ_{-1} and K one can read of $\text{tb}(K) = 1$. Then $\text{rot}(K) = 0$ by (1). Thus, K is a minimal non-loose unknot.

In order to describe more examples of non-loose knots we use front projections. Such projections are often used to represent Legendrian knots in the standard tight contact structure on \mathbb{R}^3 , many facts commonly known in that context generalize to the situation considered here with minor modifications. We refer the reader to [Et05] for information about front projections of Legendrian knots in the standard contact structure on \mathbb{R}^3 .

A convenient way to describe the standard overtwisted contact structure ξ_{-1} on S^3 is to identify the complement of the Hopf link with $T^2 \times (0, 1)$. The 3-sphere is the result of the following operation: Compactify $T^2 \times (0, 1)$ to obtain $T^2 \times [0, 1]$ and then collapse the first, respectively second, factor in $S^1 \times S^1 \times \{i\}$ to a point when $i = 0$, respectively $i = 1$. The image of the boundary components of $T^2 \times [0, 1]$ under the quotient map to S^3 is a Hopf link H in S^3 .

The restriction of ξ_{-1} to $T^2 \times (0, 1)$ is defined by

$$(8) \quad \alpha = \sin\left(\frac{3\pi}{2}z\right) dx + \cos\left(\frac{3\pi}{2}z\right) dy.$$

When one replaces the factor 3 by 1 in this formula, one obtains the tight contact structure. ξ_{-1} is the contact structure containing the minimal non-loose unknot described above. The fibers of the Hopf fibration are linear curves of slope 1 inside the tori $T^2 \times \{t\}, t \in (0, 1)$, and the components of H .

Along the Hopf link H the contact planes of ξ_{-1} are tangent to the discs formed by the images of $\{*\} \times S^1 \times [1/3, 1]$ and $S^1 \times \{*\} \times [0, 2/3]$. All discs in these two families are overtwisted, two of them are shown in Figure 4. The Hopf link H is transverse to ξ_{-1} and non-loose.

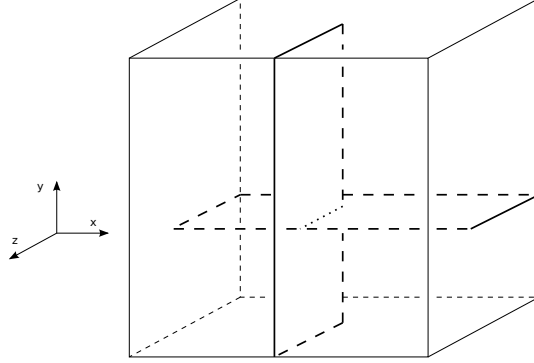

FIGURE 4. Two overtwisted discs in (S^3, ξ_{-1})

For a Legendrian curve in S^3 which is disjoint from the Hopf link H we can consider its image under the front projection $T^2 \times (0, 1) \rightarrow T^2$. Contrary to the case of the standard tight contact structure on S^3 , a vector in the tangent space of T^2 does not have a unique preimage which is tangent to ξ_{-1} . More precisely, only lines whose slope is not negative with respect to coordinates x, y on T^2 have a unique preimage. Because of this, one has to indicate which strand passes above the other strand at a double point of a front projection.

Front projections of Legendrian knots were studied by K. Dymara in [Dy04] and the following examples are from that paper. However, our conventions are different from those used in [Dy04].

Let K be a generic Legendrian knot in (S^3, ξ_{-1}) which is disjoint from H . The front projection of K is a closed curve in T^2 whose homotopy class is denoted by $(a, b) \in \mathbb{Z}^2 \simeq \pi_1(T^2)$. The only singularities of this curve are transverse double points and cusps.

Front projections of isotopic Legendrian knots are related via isotopies, Reidemeister moves and modifications of the front projection corresponding to the Legendrian knot crossing a component of H . When a segment of a Legendrian knot passing through the image of $\{z = 1\}$ the diagram changes as indicated in Figure 5, when the segment passes through $\{z = 1\}$ a similar (horizontal) modification of the front appears.

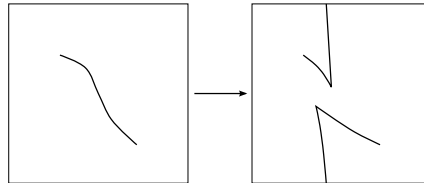

FIGURE 5. A Legendrian segment passing through $\{z = 1\}$

According to [Dy04] the Thurston-Bennequin invariant of K is

$$(9) \quad \text{tb}(K) = \text{cross}_+(K) - \text{cross}_-(K) - \frac{1}{2}\text{cusp}(K) + a \cdot b.$$

The number of cusps of the front projection is $\text{cusp}(K)$ and the number of positive, respectively negative, crossings is $\text{cross}_+(K)$, respectively $\text{cross}_-(K)$.

As explained in [Dy04] the rotation number of an oriented Legendrian knot can be read off from a generic front diagram as follows:

$$(10) \quad \text{rot}(K) = \frac{1}{2} (\text{cusp}_+(K) - \text{cusp}_-(K)) + a - b.$$

Here $\text{cusp}_+(K)$, respectively $\text{cusp}_-(K)$, is the number of positive, respectively negative cusps. We will need this formula to determine the rotation number for Legendrian knots which have projections without cusps, so we only indicate what positive/negative cusps are: A cusp is positive if the tangent space of the knot crosses $\pm\partial_z$ positively with respect to the orientation of ξ given by α .

The non-loose Legendrian knot described at the beginning of this section is diffeomorphic to the knot $K = \{(t, t, 1/2) \mid t \in [0, 1]\}$. There are more non-loose Legendrian knots in (S^3, ξ_{-1}) which can be easily described in terms of front projections.

For coprime integers m, n consider a linear curve in T^2 representing the homology class $(m, n) \in \mathbb{Z}^2 \simeq H_1(T^2; \mathbb{Z})$. If $mn \geq 0$

$$\text{tb}(K_{m,n}) = mn \quad \text{rot}(K_{m,n}) = m - n.$$

When $n = 1$ and $m \geq 1$ (or vice versa) we obtain non-loose Legendrian unknots with positive Thurston-Bennequin invariant such that the rotation number is $\pm(\text{tb}(K_{m,n}) - 1)$.

For $m = 0, n = 1$ or $m = 1, n = 0$ the curve $K_{m,n}$ lifts to a Legendrian unknot which bounds overtwisted discs, namely one of the two discs appearing in Figure 4. Of course, both these unknots are loose. However, according to Proposition 4.9 of [Dy04] their union is a non-loose Hopf link.

Finally, we show that a non-loose unknot $K_{m,n}$ with $m = 1$ or $n = 1$ and $mn > 0$ can be stabilized to a Legendrian knot isotopic to $K = K_{1,1}$ (with one of its two possible orientations). In Figure 6 we illustrate this for the case $m = 1, n = 2$, the general case is similar.

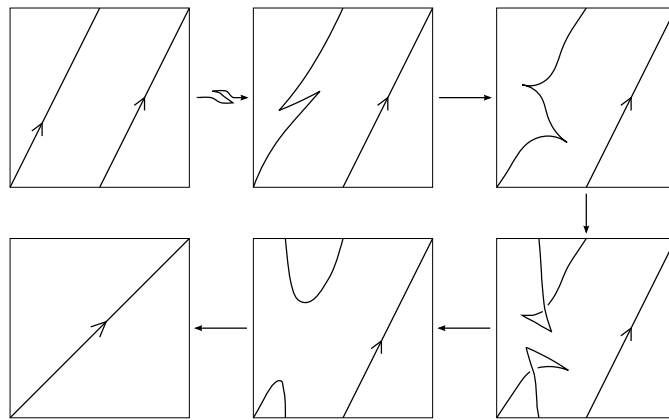

FIGURE 6. Stabilizing $K_{1,2}$ one obtains $K_{1,1}$

The first arrow indicates a negative stabilization, the third downward arrow indicates the move depicted in Figure 5 and the fourth arrow indicates two Reidemeister moves. The last and the second arrow correspond to isotopies.

Finally, we note an interesting contact diffeomorphism of ξ_{-1} .

Example 2.33. Consider the diffeomorphism ψ whose restriction on $T^2 \times (0, 1)$ (the complement of the Hopf link H) is

$$\begin{aligned} \psi|_{S^3 \setminus H} : T^2 \times (0, 1) = (\mathbb{R}^2/\mathbb{Z}^2) \times (0, 1) &\longrightarrow T^2 \times (0, 1) \\ (x, y, z) &\longmapsto (-y, -x, 1 - z). \end{aligned}$$

This map extends to a contact diffeomorphism ψ of S^3 which preserves the orientation of ξ and maps $K = K_{1,1}$ to itself but reverses the orientation of this knot.

2.6. Homotopy theory of plane fields on S^3 . In this section we discuss homotopical properties of families of contact structures. This leads to the definition of a \mathbb{Z}_2 -valued invariant d for contactomorphisms on the 3-sphere.

Recall that the tangent bundle of S^3 is trivial. One can use a Riemannian metric and a trivialization of TS^3 to associate to each oriented plane field ξ on S^3 a Gauß map

$$\begin{aligned} S^3 &\longrightarrow S^2 \\ p &\longmapsto \text{positive unit vector orthogonal to } \xi. \end{aligned}$$

By the Thom-Pontrjagin construction homotopy classes of maps from manifolds to m -spheres are in one-to-one correspondence with framed submanifolds of codimension m up to framed cobordisms (cf. [Mi]). Usually, the Thom-Pontrjagin theorem is stated for manifolds without boundary, the case when maps are fixed on the boundary of a manifold was considered e.g. by J. Etnyre [Et13] or Y. Huang [Hu14] in the context of plane fields on 3-manifolds.

This is useful since homotopy classes of plane fields on an oriented 3-manifold M correspond to homotopy classes of maps to S^2 , when $M = S^3$ these homotopy classes correspond to elements of $\pi_3(S^2)$. The homotopy groups of the 2-sphere that matter for us are well-known (see for example Chapter 4 of [Ha01] or Chapter 5 of [DFN] for a discussion based on the Thom-Pontrjagin construction):

$$\pi_3(S^2) \simeq \mathbb{Z} \qquad \pi_4(S^2) \simeq \mathbb{Z}_2 \qquad \pi_4(S^3) \simeq \mathbb{Z}_2.$$

A generator of $\pi_3(S^2)$ is the Hopf map

$$\begin{aligned} S^3 \subset \mathbb{C}^2 &\longrightarrow \mathbb{C}\mathbb{P}^1 \simeq S^2 \\ (z_0, z_1) &\longrightarrow [z_0 : z_1], \end{aligned}$$

a generator of $\pi_4(S^3)$ is the suspension of the Hopf map and a generator of $\pi_4(S^2)$ is represented by the composition of the Hopf map with its suspension.

Recall that $M = S^3 \simeq \text{SU}(2)$ and consider the $\text{SU}(2)$ -invariant framing to define the Gauß map. Homotopy classes of plane fields on S^3 are distinguished by an integer $h(\xi) \in \mathbb{Z}$, the Hopf invariant of its Gauß map defined in [H]. We recall one definition of the Hopf invariant using the Thom-Pontrjagin construction.

Let $f : S^3 \longrightarrow S^2$ be smooth and $p \in S^2$ be a regular value. Fix an oriented basis of $T_p S^2$. Then $f^{-1}(p)$ is a submanifold of codimension 2 in S^3 with normal bundle $(f|_{f^{-1}(p)})^*(T_p S^2)$. This normal bundle is framed using the preimage of

the basis of $T_p S^2$ under f . The Hopf invariant $H(f)$ is the linking number of $f^{-1}(p)$ and a push-off of $f^{-1}(p)$ in the direction of the first component of the framing. This number is independent of choices other than the homotopy class of the framing and determines f up to homotopy.

Example 2.34. The standard contact structure $TS^3 \cap iTS^3$ on $S^3 \subset \mathbb{C}^2$ is $SU(2)$ -invariant, just like the framing. Therefore, the Gauß map is constant and the Hopf invariant vanishes in this case.

A construction which is frequently used to change the homotopy class as plane field of a contact structure is the Lutz-twist. In order to describe it, recall that a transverse knot K in a contact manifold has a tubular neighborhood $N(K) \simeq S^1 \times D^2(\rho)$ such that the contact structure on $N(K)$ is isomorphic to the contact structure defined by $dz + r^2 d\vartheta$. Here $D^2(\rho)$ is a disc of radius ρ and (r, ϑ) are polar coordinates on $D^2(\rho)$.

For two smooth functions f, g on $[0, \rho]$ such that

$$\begin{aligned} f(0) &= -1 & g(r) &= -r^2 \text{ near } r = 0 \\ f(\rho) &= 1 & g(r) &= r^2 \text{ near } r = \rho \end{aligned}$$

and $fg' - g'f > 0$ we can define the contact structure

$$\xi' = \begin{cases} \ker(f(r)dz + g(r)d\vartheta) & \text{on } S^1 \times D^2(\rho) \\ \xi & \text{on the complement of } N(K). \end{cases}$$

Definition 2.35. We say that ξ' is the result of a π -Lutz twist along K .

The contact structure ξ' is well-defined up to isotopy. When one reverses the orientation of K , the resulting knot is positively transverse to ξ' .

In general, ξ' is not homotopic to ξ even as a plane field. In Chapter 4.3 of [Ge] it is explained how to determine the difference between the homotopy classes of ξ and ξ' . What is relevant for us is that applying a π -Lutz twist along a null-homologous transverse knot K in S^3 changes the Hopf invariant by $sl(K)$. The usual Lutz twist (or 2π -Lutz twist) corresponds two consecutive π -Lutz twists applied to the same knot (up to orientation), it does not change the homotopy type of the plane field.

Remark 2.36. The contact structure obtained by a π -Lutz twist along a transverse knot is always overtwisted since the discs $\{z\} \times D^2(\rho_0)$ are overtwisted when $(f(\rho_0), g(\rho_0))$ lies on the positive part of the x -axis (ρ_0 is uniquely determined because of $fg' - f'g > 0$).

Example 2.37. Let $\xi = TS^3 \cap iTS^3$ be the standard contact structure on $S^3 \subset \mathbb{C}^2$. This contact structure is $SU(2)$ -invariant. The fibers of the Hopf fibration are transverse curves, each of them has self-linking number -1 . After a π -Lutz twist along k distinct fibers, one obtains a contact structure with Hopf invariant $(k-2)k$ (c.f. p.47 in [EIF09]).

For $k = 1$ we obtain the contact structure which we are interested in most in this article.

When the plane field varies continuously the same is true for the Gauß map. Therefore, homotopy classes of 1-parameter families $\xi_t, t \in [0, 1]$, of coorientable plane fields on S^3 are in one-to-one correspondence with the set of homotopy classes of maps $g : S^3 \times [0, 1] \rightarrow S^2$ (with fixed boundary conditions). This

set is isomorphic to $\pi_4(S^2) \simeq \mathbb{Z}_2$ if $\xi_0 = \xi_1$ and the framing on S^3 is chosen so that $g(\cdot, 0) = g(\cdot, 1)$ is constant. This is the situation we consider from now on.

Following §23.4 in [DFN] we review how to determine to which element of $\pi_4(S^2)$ a given map $g : S^4 \rightarrow S^2$ corresponds.

We assume that g is smooth and pick a regular value p . Then $\Sigma = g^{-1}(p) \subset S^4$ is a framed submanifold of codimension 2. For each oriented simple closed curve γ in Σ consider its normal vector field in Σ . Then γ can be viewed as framed submanifold of S^4 of codimension 3, so it represents an element $\phi(\gamma)$ in $\pi_4(S^3) \simeq \mathbb{Z}_2$. This element depends only on the homology class $\gamma \in H_1(\Sigma; \mathbb{Z}_2)$. This defines a map

$$(11) \quad \phi : H_1(\Sigma; \mathbb{Z}_2) \rightarrow \mathbb{Z}_2.$$

Given two simple closed curves γ, γ' in Σ which intersect transversely we can replace $\gamma \cup \gamma'$ by a collection of simple closed curves representing the homology class $\gamma + \gamma'$ by smoothing the intersection points. Then, one has

$$\phi_g(\gamma + \gamma') = \phi_g(\gamma) + \phi_g(\gamma') + \gamma \cdot \gamma' \pmod{2},$$

where $\gamma \cdot \gamma'$ is the intersection pairing. Thus, $\phi_g : H_1(\Sigma; \mathbb{Z}_2) \rightarrow \mathbb{Z}_2$ is a non-degenerate quadratic form.

Recall that the Arf invariant of a \mathbb{Z}_2 -valued quadratic form on $H_1(\Sigma; \mathbb{Z}_2)$ takes values in \mathbb{Z}_2 and is non-trivial if and only if more than one half of the elements $\gamma \in H_1(\Sigma; \mathbb{Z}_2)$ have $\phi_g(\gamma) = 1$. One can show that the Arf invariant of ϕ_g depends only on the homotopy class of $g : S^4 \rightarrow S^2$.

K. Dymara [Dy01] used $\pi_4(S^2) \simeq \mathbb{Z}_2$ to define a continuous group homomorphism

$$d : \text{Diff}_+(S^3, \xi) \rightarrow \mathbb{Z}_2$$

on the group of orientation preserving contactomorphisms. It can be used to show that the group of coorientation preserving contactomorphisms $\text{Diff}_+(S^3, \xi)$ is not connected when ξ is overtwisted.

We recall the definition of d from [Dy01]. For $\psi \in \text{Diff}_+(S^3, \xi)$ choose a family of diffeomorphisms ψ_t such that $\psi_0 = \text{id}$ and $\psi_1 = \psi$. Such a family exists because ψ is orientation preserving and the group of orientation preserving diffeomorphisms of S^3 is connected by Cerf's theorem [Ce].

Consider the loop $\psi_{t*}(\xi)$ in the space of oriented plane fields on S^3 . (This is even a loop in the space of contact structures on S^3 , but we ignore this fact.) Since the Euler class of ξ in $H^2(S^3; \mathbb{Z}) = 0$ vanishes, we can pick a trivialization of ξ and extend it to a framing of S^3 .

Applying the Gauß map we obtain a loop in the space of maps from S^3 to S^2 based at the constant map. This loop can be viewed as map $S^4 \rightarrow S^2$. Now define

$$d : \text{Diff}_+(S^3, \xi) \rightarrow \pi_4(S^2) \simeq \mathbb{Z}_2 = \{0, 1\}$$

$$\psi \mapsto \left[(\psi_{t*}(\xi))_{t \in [0,1]} \right].$$

It is proved in [Dy01] that this is a well-defined homomorphism on the group of connected components of $\text{Diff}_+(S^3, \xi)$. The proof in [Dy01] that d is well-defined contains a minor gap since it is assumed that every contact structure on S^3 is contactomorphic to a contact structure which is invariant under the standard

S^1 -action on S^3 . However, the proof idea still works. In order to see this, one constructs a contact structure with Hopf invariant k using π -Lutz twists along a collection of knots transverse to the standard contact structure with self linking number -1 which are invariant under the contact diffeomorphism $(w, z) \mapsto (w, -z)$ of $S^3 \subset \mathbb{C}^2$.

The following diagram summarizes the various groups involved in the construction of the invariant d .

$$\begin{array}{ccc} \pi_1(\text{Diff}(S^3, \text{or})) = \mathbb{Z}_2 & \longrightarrow & \pi_1(\text{Cont}(S^3, \xi)) \xleftarrow{\delta} \pi_0(\text{Diff}_+(S^3, \xi)) \\ & & \downarrow \\ & & \pi_1(\text{Distr}(S^3, \xi)) \xrightarrow[\text{+ collapse}]{\text{Gauß-map}} \pi_4(S^2) = \mathbb{Z}_2 \end{array}$$

Here $\text{Distr}(S^3, \xi)$, respectively $\text{Cont}(S^3, \xi)$, denotes the plane fields homotopic to ξ , respectively the contact structures isotopic to ξ . The group of orientation preserving diffeomorphisms of S^3 is $\text{Diff}(S^3, \text{or})$. It is homotopy equivalent to $\text{SO}(4)$ according to [Ha83].

The upper line is part of the long exact sequence of the fibration $\text{Diff}(S^3, \text{or}) \longrightarrow \text{Cont}(S^3, \xi)$ given by $\varphi \mapsto \varphi_*(\xi)$, the vertical arrow is induced by the inclusion and the map $\pi_0(\text{Diff}_+(S^3, \xi)) \longrightarrow \pi_1(\text{Cont}(S^3, \xi))$ is the section of δ chosen above.

Remark 2.38. When ξ is overtwisted, Lemma 2.6 implies that there is a family of contact structures $\xi_t, t \in [0, 1]$, with $\xi = \xi_0 = \xi_1$ representing a non-trivial loop in the space of plane fields on S^3 . By Gray's theorem there is a family ψ_t of diffeomorphisms of S^3 such that $\psi_{t*}\xi = \xi_t$. Then $d(\psi_1) = 1$, i.e. d is surjective.

If one chooses the homotopy ξ_t so that it is constant on a closed ball B containing an overtwisted disc Δ such that $S^3 \setminus B$ is still overtwisted one can achieve that the support of ψ_1 is contained in the complement of B .

3. THE CLASSIFICATION OF MINIMAL NON-LOOSE UNKNOTS IN (S^3, ξ)

In this section we prove a basic result of this paper: We classify minimal non-loose Legendrian unknots in S^3 up to Legendrian isotopy. For this, we first review the classification of non-loose unknots up to contact diffeomorphism from [EIF09, Et13] where it is shown that every non-loose unknot K with $\text{tb}(K) = 1$ in S^3 carrying an overtwisted contact structure is diffeomorphic to the example K discussed at the beginning of Section 2.5. Using

- the coarse classification,
- some particular contact diffeomorphisms constructed in Section 3.2, and
- Eliashberg's theorem on overtwisted contact structures

we prove in Section 3.3 that K is isotopic to any other minimal non-loose unknot. However, this isotopy does not respect orientations of these knots in general. The proof that K and \overline{K} are not isotopic as oriented Legendrian can be found in Section 3.4 (here K is a minimal non-loose unknot and \overline{K} is the same knot with the reversed orientation).

Except for the coarse classification we will consider only non-loose Legendrian unknots K with $\text{tb}(K) = 1$ in this section. Non-loose Legendrian unknots with higher Thurston-Bennequin number will be classified in Section 4.3.

3.1. The coarse classification. In this section we recall the coarse classification of non-loose unknots in S^3 , i.e. the classification up to contactomorphism from [EIF09] and [Et13]. The following proposition summarizes the information which is needed to put a Seifert disc of a non-loose Legendrian unknot in a standard form. This implies that (S^3, ξ, K) is diffeomorphic to $(S^3, \xi_{-1}, K_{1,1})$ described in Section 2.5 and that this diffeomorphism can be chosen to preserve a fixed orientation of the contact structures.

The proposition is a consequence of the classification of tight contact structures on the solid torus (from [Gi00, Ho]), applied to the complement of a tubular neighborhood of a non-loose unknot in S^3 [EIF09].

Proposition 3.1. *Let ξ be a contact structure on S^3 and $K \subset S^3$ a non-loose unknot with $\text{tb}(K) = n > 0$. Then $\text{rot}(K) = \pm(n - 1)$.*

From this we now deduce the coarse classification of non-loose unknots in S^3 . The definition of $K_{m,n}$ can be found in Section 2.5.

Theorem 3.2. *Let ξ be an overtwisted contact structure on S^3 and K a non-loose Legendrian unknot with $\text{tb}(K) = n > 0$ and $\text{rot}(K) = \pm(n - 1)$. Then (S^3, ξ, K) is diffeomorphic to $(S^3, \xi_{-1}, K_{\pm 1, \pm n})$.*

We give the proof of this because it yields a normal form for the characteristic foliation on the Seifert surface of a non-loose unknot which will be used later.

Proof. Let ξ be an overtwisted contact structure on S^3 and K a non-loose oriented Legendrian unknot. By Lemma 2.31 $\text{tb}(K) = n > 0$. Choose an oriented spanning disc for K . We will simplify the characteristic foliation on D to bring it in a standard form. For this we assume that D is generic so that the singular points of $\xi(D)$ are either elliptic or hyperbolic.

We first consider the singular points of $\xi(D)$ along ∂D and simplify the characteristic foliation as follows.

- Positive hyperbolic points on ∂D whose unstable leaves lie on ∂D are replaced by positive elliptic points (cf. Figure 2 on p. 9).
- Negative hyperbolic points on ∂D whose stable leaves lie on ∂D are replaced by negative elliptic points.

After this, a negative (positive) elliptic singularity is connected (in ∂D) to singularities which are positive (negative) elliptic or negative (positive) hyperbolic. The second case can be further simplified using the elimination lemma which provides a deformation of D canceling a hyperbolic point with an elliptic singularity of the same sign while keeping the boundary of D fixed throughout the deformation.

From now on we assume that there are no canceling pairs of singularities left on ∂D . Then, if there is an elliptic singularity left, all singular points on ∂D are elliptic, they alternate between negative and positive along ∂D , and the Thurston-Bennequin invariant of K is negative (this can be seen by a direct computation in a model). If ∂D contains no singular points, then $\text{tb}(K) = 0$ which is impossible for a non-loose Legendrian unknot in an overtwisted contact manifold. Therefore, $\xi(D)$ has only hyperbolic points on the boundary which alternate between positive and negative and have retrogradient connections between them.

The interior of D can be simplified further. Generically, there are no connections between hyperbolic points such that the connecting separatrix lies in the interior of D . Then every unstable leaf of a negative hyperbolic singularity has a negative

elliptic singularity as its ω -limit set since ξ is tight on $M \setminus K$. Therefore, all negative hyperbolic points of $\xi(D)$ in the interior of D can be eliminated and the same is true for the positive hyperbolic points in the interior of D .

We assume $\text{rot}(K) \geq 0$. Because K is non-loose, $\xi(D)$ has no closed leaf in the interior of the disc which could act as sink or source. But only finitely many leaves are stable or unstable leaves of hyperbolic singular points. So $\xi(D)$ must have at least one positive and at least one negative singular point in the interior of D to act as sink or source for infinitely many leaves of $\xi(D)$. According to (4) (on p. 9)

$$\text{rot}(K) = e_+ - e_- = n - 1.$$

Therefore, there are at least n positive elliptic singularities. But there cannot be more since on the boundary, there are exactly n singular points whose unstable leaves can come from positive elliptic singularities. If no leaf coming from an elliptic singular point ends at a hyperbolic point, then the basin of this elliptic singularity is either a sphere or it is the entire disc. But this is not the case since the disc D contains elliptic singular point of both signs.

It follows that $e_+ = n$ (and $e_- = 1$) and every positive elliptic singular point is connected to a negative hyperbolic point in ∂D . All unstable leaves of positive hyperbolic on ∂D end at the same negative elliptic singular point in the interior. This determines the characteristic foliation on D up to homeomorphism (c.f. the middle part of Figure 7 for $n = 1$). \square

Definition 3.3. Assume that $S^2 \subset (S^3, \xi)$ such that the characteristic foliation has only isolated singularities. Let Γ_-^* be Γ_- with unstable leaves connecting to positive hyperbolic singularities removed and Γ' a connected component of Γ_-^* . By $e_-(\Gamma')$, respectively $h_-(\Gamma')$, we denote the number of singularities of $\xi(S^2)$ in Γ' whose index is $+1$, respectively -1 . Using Γ_+ instead of Γ_- one defines $e_+(\Gamma')$, $h_+(\Gamma')$.

In general, if $\Gamma_{t,-}$ is a tree for all $t \neq t_0$ close to t_0 and some unstable leaves of negative singularities take part in a retrogradient connection on $S^2 \times \{t_0\}$, then for each connected component Γ' of $\Gamma_{t_0,-}^*$

$$(12) \quad e_-(\Gamma') - h_-(\Gamma') = 1 - \text{number of retrogradient connections starting at } \Gamma'.$$

Since Γ_t is a tree for $t \neq t_0$, the left hand side of (12) is ± 1 or 0 .

Consider the particular case when $S^2 \times \{t_0\}$ contains a non-loose unknot K with $\text{tb}(K) = 1$. From the proof of Theorem 3.2 it follows that

$$e_-(\Gamma') - h_-(\Gamma') = \pm 1$$

and that Γ' is a tree for all components Γ' of Γ_-^* . There is exactly one component Γ' such that $e_-(\Gamma') - h_-(\Gamma') = -1$ and this is the component where both unstable leaves forming the retrogradient connections on S^2 start.

The converse of this statement follows immediately from the proof of Theorem 3.2.

Corollary 3.4. *Let S^2 be a sphere in a contact manifold (M, ξ) such that the characteristic foliation has*

- *precisely two retrogradient connections,*
- *the corresponding unstable leaves start at the same connected component of Γ_-^* ,*

- Γ_-^* has exactly three connected components which are all trees, and
- $\xi(S^2)$ has no closed leaf.

Then $\xi(S^2)$ contains a minimal unknot which is non-loose in a small tubular neighborhood of the sphere.

Remark 3.5. Recall that the positive/negative stabilization of a non-loose Legendrian unknot K with $\text{tb}(K) > 1$ results in a non-loose Legendrian unknot K' with $\text{tb}(K') = \text{tb}(K) - 1$ and $\text{rot}(K') = \text{rot}(K) \pm 1$.

By Theorem 3.2 the positive stabilization of $K_{1,n}$ is loose, and we have seen before that the negative stabilization of $K_{1,n}$ is non-loose when $n > 1$.

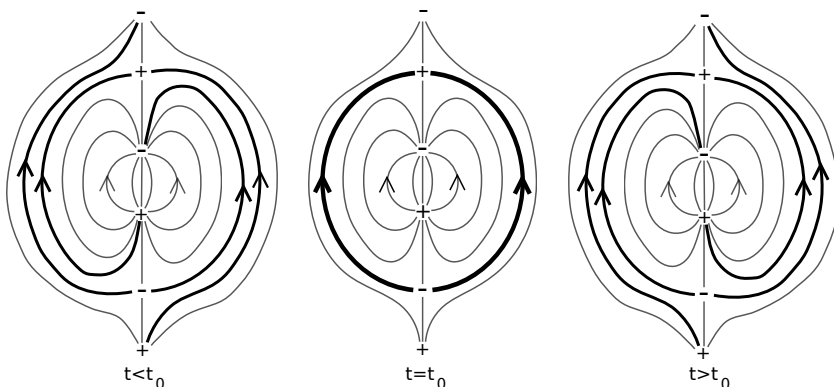

FIGURE 7. Examples of characteristic foliations on spheres. The thickened lines in the middle figure form a minimal non-loose unknot.

Assume that $S^2 \times \{t_0\}$ contains a non-loose unknot and that the characteristic foliation on each disc bounding the knot in S^2 is simplified as in the proof of the previous Theorem, i.e. there are exactly two hyperbolic singularities and four elliptic ones. It is interesting to consider the characteristic foliation on nearby spheres. Figure 7 shows the characteristic foliation on $S^2 \times \{t\}$ for $t < t_0$ (on the left) and $t > t_0$ (on the right) where t is close to t_0 . Lemma 2.20 describes the behavior of stable/unstable leaves of the two hyperbolic singularities, and the presence of a connection between two hyperbolic points is a codimension 1 phenomenon. In view of this, the presence of a minimal non-loose unknot of (S^3, ξ_{-1}) on an embedded sphere is a codimension two phenomenon.

Overtwisted discs are not directly visible in Figure 7 although there is an obvious Legendrian knot violating the Thurston-Bennequin inequality. In order to see overtwisted discs appear more explicitly, we will use a schematic representation of the characteristic foliation on spheres. This representation will be employed later, too. Consider a tubular neighborhood $S^2 \times (t_0 - \varepsilon, t_0 + \varepsilon)$, $\varepsilon > 0$, of an embedded sphere $S^2 = S_{t_0}^2 = S^2 \times \{0\}$ in a contact manifold (M, ξ) and assume that

- $\xi(S_{t_0}^2)$ has a retrogradient saddle-saddle connection,
- the product decomposition on the tubular neighborhood is generic in the sense that all singular points of $\xi(S_{t_0}^2)$ are non-degenerate, and
- $\xi(S_{t_0}^2)$ has no closed leaf.

Note that we do not require that there is only one retrogradient connection for $t = 0$ (this case is not really interesting because of Lemma 2.23).

As in the proof of Lemma 2.23 we consider the graph $\Gamma_{t,-}$ consisting of unstable leaves of negative points of $\xi(S_t^2)$. Solid lines will represent the connected components obtained from $\Gamma_{t,-}$ by removing all stable leaves which do take part in a retrogradient connection at $t = 0$. We are only interested in the homotopy type of these components. In all cases under consideration these components will be simply connected, and we represent them by solid lines.

The unstable leaves which do take part in a retrogradient connection at $t = 0$ are dashed. We will always draw the graph before and after the retrogradient connections occur, and we will use dotted lines to indicate where a stable leaf of $\Gamma_{t,-}$, $t < 0$, which takes part in the retrogradient connection ends after a retrogradient connection in the future.

From such a diagram one can read off the number of connected components of $\Gamma_{t,-}$ and their Euler characteristics before and after one or more retrogradient connections occur. Although $\Gamma_{t,+}$ is not represented, a lot of information about $\Gamma_{t,+}$ can be recovered from the diagrams: Under our assumptions, $\Gamma_{t,+}$ is homotopy equivalent to $S^2 \setminus \Gamma_{t,-}$ for $t \neq 0$. In particular, these diagrams can be used to determine whether S_t^2 contains an overtwisted disc of ξ .

Let $S_{t_0}^2 \subset (S^2 \times [-1, 1], \xi)$ be a sphere containing a disc where the characteristic foliation is homeomorphic to the one shown in the middle of Figure 7. We want to study nearby spheres S_t^2 of the product decomposition. The union of the dashed and solid lines in the top diagram represents $\Gamma_{t,-}$ for $t < t_0$ while the dotted lines represent the future positions of the unstable leaves in the retrogradient connection. The bottom diagram shows $\Gamma_{t,-}$ for $t > t_0$. The solid straight horizontal line in the middle of each of the four diagrams in Figure 8 corresponds to the negative hyperbolic singularity in Figure 7, each of the other two solid arcs represents one of the negative elliptic singularities in Figure 7.

The situation when two retrogradient connections occur at the same time in a movie is unstable: After a small perturbation of the product structure on $S^2 \times [-1, 1]$, the retrogradient connections (marked with A, B) will still occur, but they will lie on different spheres $S^2 \times \{t_A\}, S^2 \times \{t_B\}$. The left diagram in the middle row represents $\Gamma_{t,-}$ for $t \in (t_A, t_B)$ for $t_A < t_B$. Finally, the diagram on the right-hand side is analogous for the case $t_B < t_A$. In both cases there are obvious overtwisted discs.

In the following remark we consider minimal non-loose unknots on spheres such that one of the singular points of the characteristic foliation is degenerate. The assumptions made here are very specific and tailored to the application we have in mind.

Remark 3.6. Assume that a minimal non-loose unknot is contained in an embedded sphere $S_{t_0}^2$ containing exactly two retrogradient connections and that all singular points of $\xi(S_{t_0}^2)$ are isolated. Recall that the index of such singularities has to be ± 1 or 0 and fix a tubular neighborhood $N = S^2 \times [t_0 - \varepsilon, t_0 + \varepsilon]$. We assume that N is so thin that $\xi(S_t^2)$ is Morse-Smale for all $t \neq t_0$.

Later, it will be relevant to consider the case when there is a single degenerate negative singularity x in Γ' with index zero such that one of its unstable leaves

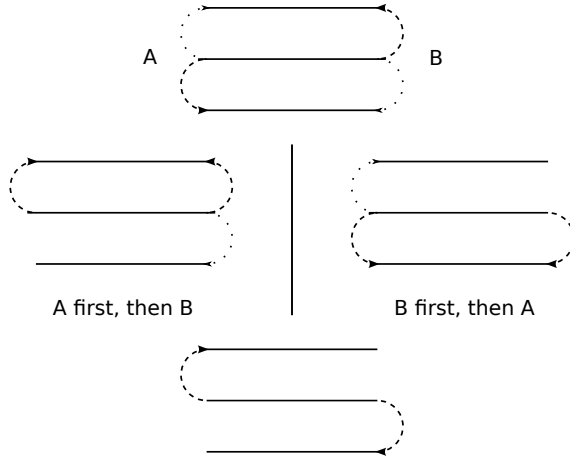

FIGURE 8. Schematic representation of the movie on the spheres in a product neighborhood of a sphere carrying a minimal non-loose Legendrian unknot with two possible resolutions.

takes part in the retrogradient connection with the positive singularity z . Then $e_-(\Gamma') - h_-(\Gamma') = -1$ and x is the endpoint of an unstable leaf γ' of a hyperbolic singularity x' in Γ' .

If one perturbs the product structure on N slightly relative to a neighborhood of ∂N , then there is a retrogradient connection on one of the spheres of the perturbed product decomposition involving the same stable leaf of z but it may happen that this stable leaf is now the unstable leaf of x' .

Of course, the discussion when a positive singular point is degenerate is completely analogous.

3.2. Contact diffeomorphisms preserving non-loose unknots. For the proof of our classification results we need a contact diffeomorphism

$$\psi : (S^3, \xi_{-1}) \longrightarrow (S^3, \xi_{-1})$$

which preserves K , the orientation of the plane field and has $d(\psi) \neq 0$. This will be the content of the second example in this section, the first is a preparation for the second. We will use the consequences of the Thom-Pontrjagin construction which were outlined in Section 2.6.

Before explaining the construction, we note that some of the material presented here could be rephrased using the methods developed by Y. Huang in [Hu13, Hu14].

First, we consider how a particular operation on a given contact structure affects the Hopf invariant. This construction will yield an alternative construction of a non-loose unknot in S^3 .

Example 3.7. Start with the standard contact structure $\xi_{st} = TS^3 \cap iTS^3$ on $S^3 \subset \mathbb{C}^2$. It is $SU(2)$ -invariant, and we use it to orient S^3 . We choose an $SU(2)$ -invariant framing to define the Gauß maps (the Gauß map of ξ_{st} is constant).

Consider the transverse unknot $H = S^1 \times \{0\}$ together with a tubular neighborhood $N(H) \simeq S^1 \times D^2$ such that the contact structure on this neighborhood is invariant under translations in the S^1 -direction and under rotations of the disc.

We fix a round 2-sphere $S_0 \subset S^3$ which is orthogonal to $\mathbb{C} \times \{0\} \subset \mathbb{C}^2$ such that $S_0 \cap N(H) \supset \{1\} \times D^2$ (here $1 = (1, 0) \in \mathbb{C}^2$ is a point on H) and we orient S_0 so that $\xi_{st}(S_0)$ has a positive singular point in the midpoint of the disc $\{1\} \times D^2$. Then S_0 is convex and $\xi_{st}(S_0)$ has exactly two singular points (both elliptic), these are the intersection points of S_0 with L .

We isotope ξ_{st} to a new contact structure ξ with the following properties:

- ξ is S^1 -invariant on $N(H) \simeq S^1 \times D^2$.
- The characteristic foliation of ξ on $\{1\} \times D^2$ is diffeomorphic to the one shown in Figure 9. In particular, there is a disc D_{in} such that ∂D_{in} is transverse to ξ and $\xi(D_{in})$ has two positive elliptic singularity, one negative hyperbolic one and no closed leaves.
- There is an involution ρ_1 of D_{in} which preserves the singular foliation on D_{in} but interchanges the two positive elliptic points.

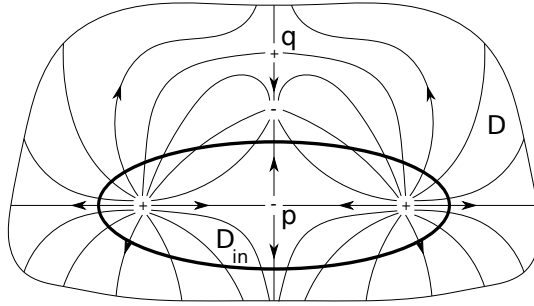

FIGURE 9. Characteristic foliation on D and D_{in}

To obtain a new plane field ζ_1 we consider a product neighborhood $S^2 \times (-\infty, \infty)$ around the convex sphere $S^2 = S^2 \times \{0\}$ oriented so that the product orientation is positive and the contact structure is translation invariant.

Because the boundary of D_{in} is transverse to the characteristic foliation, there is an isotopy ρ_s , $s \in (-1, 1)$, of D_{in} interpolating between the identity of D_{in} and the involution ρ_1 mentioned above such that

- $\rho_s = \text{id}$ for s close to -1 ,
- ρ_s is constant and preserves the characteristic foliation for s close to 1 ,
- ρ_s preserves the characteristic foliation near ∂D_{in} for all s ,
- the hyperbolic singularity p is a fixed point of ρ_s for all s ,
- the unstable leaves of p are interchanged by ρ_s for s close to 1 , and
- as s varies from -1 to 1 , the unstable leaves of p rotate by a counter clockwise half turn.

A new plane field ζ_1 is determined (up to homotopy) by the requirement that $\zeta_1 = \xi$ outside of $D_{in}^2 \times (-1, 1)$ and the characteristic foliation of ζ_1 on $D_{in}^2 \times \{s\}$ is the image of the characteristic foliation of ξ under ρ_s .

For $k \in \mathbb{N}$ the plane field ζ_k is defined by applying the above operation k times. For negative k one uses $|k|$ -times the isotopy ρ_s^{-1} instead of ρ_s .

When one passes from ξ to ζ_k , the homotopy type of the plane field changes. In order to determine how, we choose a framing of the tangent bundle so that TD is tangent to the span of the first two components of the framing and so that the

framing is vertically invariant on the ball $D \times (-1, 1) \subset D \times (-\infty, \infty)$ (recall that $\zeta_k = \xi$ outside of this ball). We consider the Gauß maps g, g_k of ξ, ζ_k .

Because all singular points of the characteristic foliation on D are non-degenerate, we may assume that $g(-TD^2(p, 0))$ is a regular value of g and g_k . By construction, the Thom-Pontrjagin submanifolds of g and g_k coincide, but their framings are different. A direct computation in terms of local coordinates near the negative hyperbolic singularity coordinates shows that the Hopf invariants satisfy $H(g_k) - H(g) = k$.

We continue to study the plane fields from the above example.

Lemma 3.8. *For $k > 0$, the plane field constructed above cannot be a contact structure. If $k \leq 0$, then the Hopf invariant of the resulting plane field is k and it can be chosen to be a contact structure.*

Proof. The first part is immediate from Lemma 2.20. We now sketch the argument for the second part.

By Lemma 2.4 of [Gi00], it suffices to consider neighborhoods of the instances s where one or two retrogradient connections occur (for all other s the characteristic foliation on $D \times \{s\}$ admits a dividing set). Let s_0 be such an instance. Since all singular points have non-vanishing divergence, the corresponding characteristic foliation on $D \times \{s_0\}$ is the characteristic foliation of a contact structure by Proposition II.1.2 of [Gi91] and there is a germ of a contact structure ξ on $D \times (-1, 1)$ near $D \times \{s_0\}$ which induces the singular foliation \mathcal{F}_{s_0} on D_{s_0} . Now Lemma 2.20 stated above is slightly weaker than what is actually proved in [Gi91] (Giroux shows a more analytic condition formulated as equation (‡) on p. 638 in [Gi00]). This stronger condition is also satisfied by our movie.

In order to arrange that the characteristic foliation of ξ near $D \times \{s_0\}$ coincides with the singular foliation we have defined, one can choose a foliation tangent to ξ and transverse to $D \times \{s_0\}$ on a tubular neighbourhood of $\partial D_{in} \times S^1$ and consider flows with compact support in that collar tangent to the chosen foliation which preserve $D \times \{s_0\}$. By the contact condition, there is a flow such that the characteristic foliation of the pull back of ξ with respect to this flow is diffeomorphic to the singular foliation we have constructed. \square

We now specialize to $k = -1$. There is exactly one positive hyperbolic singularity $q \in D$ and both stable leaves of q come from D_{in} . When $k = -1$, one can choose ρ_s so that for each stable leaf of q there is exactly one coincidence with an unstable leaf of q of ρ_s^{-1} for exactly one $s \in (-1, 1)$.

If we choose this parameter to be the same for both coincidences (say for $s = 0$) the union of the pair of stable/unstable leaves on the sphere $S^2 \times \{s = 0\}$ is a minimal non-loose unknot K by 3.4.

Using this description of a minimal non-loose unknot we next construct an example of a family of contact structures on S^3 which is not homotopic to the constant family of plane fields. By Gray's theorem this produces a contact diffeomorphism ψ with $d(\psi) \neq 0$. Of course, such a contact diffeomorphism can be produced using Eliashberg's classification theorem. Thus, the main point of the following lemma is that we do not only control $d(\psi)$ but also $\psi(K)$ where K is the non-loose unknot from the above example.

Lemma 3.9. *Let $K \subset S^3$ be the standard non-loose unknot in (S^3, ξ_{-1}) . Then there is $\psi \in \text{Diff}_+(S^3, \xi_{-1})$ which*

- *preserves the orientation of ξ_{-1} and $d(\psi) = 1$,*
- *$\psi(K) = K$ while the orientation of K is reversed.*

Proof. We continue to consider the situation from Lemma 3.8 for $k = -1$. Our goal is to obtain a non-trivial loop of contact structures on S^3 which preserves K as a set.

For $\tau \in [0, 2\pi]$ let $\psi_\tau : S^3 \rightarrow S^3$ be the composition of two rotations: The first is a rotation around a plane orthogonal to H by the angle τ while the second rotation is a rotation by $-\tau/2$ around the plane containing H . The family of contact structures $\psi_\tau(\xi_{st})$ is constant because these rotations preserve the complex structure on \mathbb{C}^2 .

As above, deform ξ_{st} to a new contact structure so that on the second factor of $N(H) = S^1 \times D^2$ the characteristic foliation of ξ is diffeomorphic to the one shown in Figure 9. This can be done relative to a neighborhood of $\{0\} \times S^1$ and ξ can be chosen so that it is invariant under $\psi_{2\pi}$. Then the loop of contact structures $\xi(\tau) = (\psi_\tau)_*(\xi)$, $\tau \in [0, 2\pi]$, is contractible in the space of plane fields because ξ is homotopic to ξ_{st} and ξ_{st} is preserved by ψ_τ .

Let R be the unit vector tangent to the fibers of the Hopf fibration. This vector field is positively transverse to ξ_{st} everywhere. We may assume that R is a component of the framing and that $-R$ is a regular value of the Gauß map of ξ . Since the loop ξ_τ , $\tau \in [0, 2\pi]$, is null homotopic, the associated Thom-Pontrjagin manifold of $S^3 \times S^1$ (carrying the family of plane fields tangent to S^3 induced by ξ_τ) is framed cobordant to the empty manifold. In particular, the sum of the Arf invariants of all components of the Thom-Pontrjagin submanifold is zero.

We now modify the family ξ_τ so that the framing of one component of the Thom-Pontrjagin submanifold changes so the associated Arf invariant changes while we do not modify the framing of other components.

For this we consider the family of thickened spheres $\psi_\tau(S^2 \times (-\delta, \delta)) \subset S^3$ and apply to each such family the modification discussed in Example 3.7. We obtain a closed loop of contact structures $\xi_{-1}(\tau)$. The only part of the Thom-Pontrjagin submanifold affected by this construction is the component containing H . The framing of this submanifold changes so that the framing makes one full turn (compared to a $SU(2)$ -invariant framing) as one moves along H and also as one moves along $\{p\} \times [0, 2\pi]$ for $p \in H$.

We identify $S^3 \times \{0\}$ with $S^3 \times \{2\pi\}$ and consider the situation in $S^3 \times S^1$. The Thom-Pontrjagin submanifold associated to the constant family ξ is the same as the Thom-Pontrjagin submanifold of $\psi(\tau)$ but the framing of the component containing H has changed in such a way that the Arf invariant also changes. This implies that $\xi_{-1}(\tau)$ is a homotopically non-trivial loop of plane fields on S^3 .

Note that by construction, we also obtain a family K_τ of Legendrian knots (with respect to $\xi_{-1}(\tau)$) so that $K_{2\pi} = K_0$, but the orientation is reversed. Thus, $\psi_{2\pi}$ is a contact diffeomorphism of ξ_{-1} which reverses the orientation of K , preserves the orientation of ξ_{-1} and has $d(\psi_{2\pi}) \neq 0 \in \pi_4(S^2)$. Thus, $\psi = \psi_{2\pi}$ has the desired properties. \square

3.3. The classification up to isotopy for non-oriented unknots. In this section we classify minimal non-oriented non-loose unknots in S^3 up to isotopy. This classification makes heavy use of Eliashberg's classification theorem (Theorem 2.5) as discussed on p. 5: The overtwisted disc we will use to apply that theorem will vary in a controlled fashion.

In the following we denote the minimal non-loose unknot described at the beginning of Section 2.5 by L and \bar{L} denotes the same knot with the reversed orientation.

Theorem 3.10. *Let ξ_{-1} be the overtwisted contact structure with Hopf invariant -1 on S^3 . Then every minimal non-loose Legendrian unknot K is isotopic to L or \bar{L} .*

Proof. Let K be a non-loose unknot. For convenience, we remove two open Darboux balls from the complement of $L \cup K$ such that the boundary of each of these balls is convex. We thus view L as non-loose knot in $S^2 \times [-1, 1]$. The contact isotopy moving L to K will have support inside this smaller space.

According to the coarse classification of non-loose unknots there is a contact diffeomorphism ψ with $\psi(L) = K$. In particular, ψ preserves the orientation of S^3 and by Cerf's theorem there is an isotopy $\psi_\sigma, \sigma \in [0, 1]$, of S^3 connecting ψ to the identity. By Lemma 3.9 we may assume that $d(\psi) = 0$. Because the space of 3-balls in S^3 is simply connected (p.5 in [Ce]), we can choose ψ_σ so that it preserves the two balls we have removed from S^3 .

In order to construct the contact isotopy moving L to K we will apply Gray's theorem to a family of contact structures on $N = S^2 \times [-1, 1]$. The parameter space will be $I^2 = [0, 1] \times [0, 1]$. We now describe

- the contact structures $\xi(\sigma, \tau)$ on N , and
- restrictions on the product decomposition $N \simeq S^2 \times [-1, 1]$

for parameter values (σ, τ) in a neighborhood of ∂I^2 and near the boundary of M .

$t = \pm 1$	$\xi(\sigma, \tau) = \xi_{-1}$ independent of σ and τ . The product decomposition near ∂N is independent of σ, τ .
$\tau = 0$	$\xi(\sigma, \tau) = \xi_{-1}$ independent of σ . The product decomposition of N is the image of the original product decomposition under ψ_σ .
$\tau = 1$	$\xi(\sigma, \tau) = (\psi_\sigma)_* \xi_{-1}$. The product decomposition of N is the image of the original product decomposition under ψ_σ .
$\sigma = 0$	$\xi(\sigma, \tau) = \xi_{-1}$ independent of τ . $N \simeq S^2 \times [-1, 1]$ is such that $L \subset S^2 \times \{0\}$ is in normal form (c.f. the proof of Theorem 3.2).
$\sigma = 1$	$\xi(\sigma, \tau) = \xi_{-1}$ independent of τ . $N \simeq \psi_1(S^2 \times [-1, 1])$ so that $K \subset \psi_1(S^2 \times \{0\})$ is in normal form.

Figure 10 illustrates the situation: Each point in the box represents a sphere, horizontal lines represent the manifold $S^2 \times [-1, 1]$ and some vertices are labeled with coordinates. On the front face $\{\tau = 1\}$, there is an obvious family (parametrized by σ) of Legendrian knots interpolating between K and L . This is indicated by the curved line on the front face of the box. However, the contact structure is not constant. The straight lines on the top face, respectively bottom face, correspond to the knot L , respectively K . On the back face $\{\tau = 0\}$ the contact structure is constant but there is no obvious isotopy moving K to L .

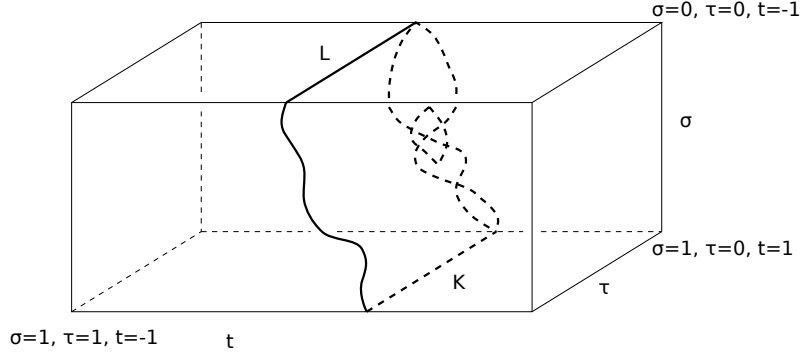

FIGURE 10. The setup for the construction of an isotopy from L to K

For $\tau = 1$, the knot $\psi_\sigma(L)$ is contained in a sphere of the product decomposition. One should keep in mind that the product decomposition of N depends on σ and τ . The curved line on the front of the box is

$$\{(T_\pm(\xi(\sigma, 1)), \sigma, 1) \mid \sigma \in I\}.$$

The union of the left-most, respectively right-most, pieces of the dashed curves on the back side $\{\tau = 0\}$ are

$$\{(T_-(\xi(\sigma, 1)), \sigma, 1) \mid \sigma \in I\}, \text{ respectively } \{(T_+(\xi(\sigma, 1)), \sigma, 1) \mid \sigma \in I\}.$$

For $\sigma, \tau \in \partial I^2$ we have constructed contact structures $\xi(\sigma, \tau)$ on N which are constant near ∂N . Our **current goal** is to extend this family to an I^2 -family of contact structures. Then we can use Grays theorem to find the desired Legendrian moving K to L in $(N, \xi_{-1}|_N)$.

In order for this to be possible, we have to be able to extend $\xi(\sigma, \tau)$ as a family of plane fields. But this is obvious since we assumed $d(\psi_1) = 0$, i.e. there is an I^2 -parametric family $\zeta(\sigma, \tau)$ of plane fields on N which coincides with the contact structures on the boundary ∂I^2 (as described in the table above).

In order to ensure that Theorem 2.5 can be applied we will make a particular choice for $\zeta(\sigma, \tau)$, and we also deform the family $\xi(\sigma, \tau)$ on the boundary. Then we will argue that $\zeta(\sigma, \tau)$ is homotopic to a family of contact structures $\xi(\sigma, \tau)$ for (σ, τ) in I^2 relative to the boundary of the parameter space and such that all plane fields are constant on a neighborhood of ∂N .

In the next two steps we modify the product decomposition of N for $\tau = 0$ in order to achieve that Theorem 2.5 can be applied effectively.

Recall that $T_-(\xi)$ is defined by the requirement that ξ is tight on $S^2 \times [-1, T_-(\xi))$ and overtwisted on $S^2 \times [-1, t)$ for all $t > T_-(\xi)$. T_+ is defined similarly requiring tightness of ξ on $S^2 \times (T_+(\xi), 1]$.

We will write $T_\pm(\sigma, \tau)$ instead of $T_\pm(\xi(\sigma, \tau))$, and $S^2(t, \sigma, \tau) = S^2 \times \{t\} \times \{(\sigma, \tau)\}$.

Reduction to the case $T_-(\sigma, 0) < T_+(\sigma, 1)$ for all $\sigma \notin \{0, 1\}$: Consider the functions $T_\pm(\xi(\sigma, 0))$ defined in (5). By Lemma 2.25 they are continuous and $\xi(\sigma, \tau)$ is overtwisted on every neighborhood of $S^2 \times [-1, T_-(\sigma, \tau)]$ and $S^2 \times [T_+(\sigma, \tau), 1]$. According to Lemma 2.26 $T_-(\sigma, 0) \leq T_+(\sigma, 0)$.

By Lemma 2.21 there are no closed leaves, by Lemma 2.23 there must be at least two retrogradient connection and generically there are at most two retrogradient connections on every sphere $S^2(t, \sigma, 0)$ if $T_-(\sigma, 0) = T_+(\sigma, 0)$. For a generic product decomposition of N the equality $T_-(\sigma, 0) = T_+(\sigma, 0)$ happens for finitely many instances

$$0 = \sigma_0 < \sigma_1 \dots < \sigma_n = 1.$$

According to Remark 2.24 (c.f. p. 11) the equality $T_-(\sigma_i, 0) = T_+(\sigma_i, 0)$ implies that $S^2 \times \{T_-(\sigma_i, 0)\}$ contains a minimal non-loose unknot K_{σ_i} . After an isotopy of $N \times I \times \{\tau = 1\}$ preserving the hypersurfaces $\{\sigma = \text{const}\}$ to achieve that the non-loose unknots in $S^2(T_+(\sigma_i, 0), \sigma_i, 0)$ and $S^2(T_+(\sigma_i, 1), \sigma_i, 1)$ coincide we can consider layers $[\sigma_i, \sigma_{i+1}] \times I$ in the parameter together with deformed plane fields $\zeta'(\sigma, \tau)$ satisfying boundary conditions along $\{\sigma = \sigma_i\}$ similar to the ones given in the table above. The only difference is that along $\{\sigma = \sigma_i\}$ the contact structure is not constant: Let

$$\widehat{\psi}_i : (N \times \{(\sigma_i, 1)\}, \xi(\sigma_i, 1)) \longrightarrow (N \times \{(\sigma_i, 0)\}, \xi(\sigma_i, 0))$$

which maps the non-loose unknot $\psi_{\sigma_i}(L) \subset N \times \{\sigma_i, 1\}$ to the non-loose unknot on $S^2 \times \{(T_-(\sigma_i, 0), \sigma_i, 0)\}$ such that $d(\widehat{\psi}_i) = 0$. As above, we then use Cerf's theorem to obtain an isotopy from id_N to $\widehat{\psi}_i$ and hence a family of contact structures.

Since $d(\widehat{\psi}_i) = 0$ for all i , the resulting family of plane fields on

$$(\partial N \times I^2) \cup \left(\bigcup_i N \times \{\sigma_i\} \times I \right) \cup (N \times \partial I^2)$$

extends to $N \times I^2$. This reduces the construction of an I^2 -parametric family of contact structures to the case when $T_-(\sigma, 0) < T_+(\sigma, 0)$ for all $\sigma \notin \{0, 1\}$. In particular, no sphere $S(t, \sigma, \tau)$ with $\sigma \notin \{0, 1\}$ contains a non-loose unknot. From now on we assume that this was the case from the beginning.

Elimination of locally non-loose unknots: We want to reduce to the case when for all $\sigma \in (0, 1)$ there are no spheres $S^2(T_{\pm}(\sigma, 0), \sigma, 0)$ containing a Legendrian unknot K such that

- $\xi(\sigma, 0)$ is overtwisted on every tubular neighborhood of that sphere and
- there is a neighborhood which becomes tight when K is removed,
- the complement of $S^2(T_{\pm}(\sigma, 0), \sigma, 0)$ remains overtwisted when K is removed.

By Remark 2.24 the characteristic foliation of $\xi(\sigma, 0)$ on $S^2(T_{\pm}(\sigma, 0), \sigma, 0)$ has precisely two retrogradient connections (each of these retrogradient connections is indicated by a line in Figure 11 below) but now there is an overtwisted disc of $\xi(\sigma, 0)$ in the complement of $S^2(T_{\pm}(\sigma, 0), \sigma, 0)$.

By Theorem 2.5 one can eliminate the intersection point in the left-hand part of Figure 11 as indicated in the right-hand side of that figure.

Extension of $\xi(\sigma, \tau)$ to a neighborhood of the boundary of the parameter space: Recall that $\zeta(\sigma, \tau)$ is a contact structure whenever $(\sigma, \tau) \in \partial I^2$. We homotope this family of plane fields relative to ∂I^2 to achieve that there is a collar of ∂I^2 such that there are no simultaneous retrogradient connection on the interior of a collar of $\{\tau = 1\} \cup \{\sigma = 0 \text{ or } \sigma = 1\}$.

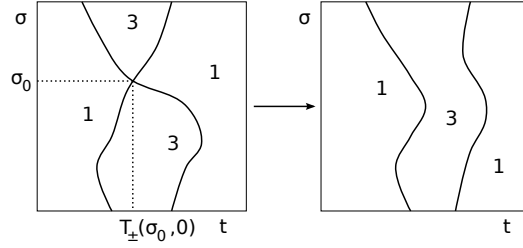
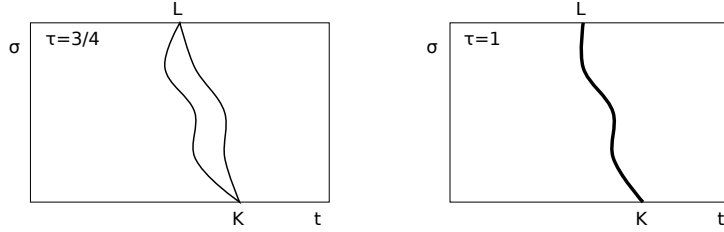

FIGURE 11. Removing a locally (but not globally) non-loose unknot

For the construction of this perturbation one uses a slight generalization of Lemma 2.20: We perturb the spheres $S^2 \times \{0\}$ so that one retrogradient saddle-saddle connections occur for $t = 0$ while the other such connections occurs for $t > 0$ unless $\sigma = 0$ or $\sigma = 1$. This is indicated in Figure 12. The bold line on the right hand side represents simultaneous retrogradient connection while in the left part, for slightly smaller τ , the two connections occur on different spheres of the product decomposition of $N \times (\sigma, \tau)$.

 FIGURE 12. The simplification of $\xi(\sigma, \tau)$ near $\{\tau = 1\}$

From now on we assume that $\zeta(\sigma, \tau)$ is a contact structure for $3/4 \leq \tau \leq 1$.

Construction of plane fields $\zeta''(\sigma, \tau)$, $\sigma, \tau \in I$: We are now ready to homotope the family of plane fields $\zeta(\sigma, \tau)$ so that the result is contact and overtwisted on parts of N for enough parameter values (σ, τ) that we will be able to apply Theorem 2.5. The notation T_{\pm} will be used in the same sense as before, the argument of this function will always be an overtwisted contact structure on a collar of a boundary component of N .

The homotopy consists of two steps. In the first step, we will produce a family of plane fields $\zeta'(\sigma, \tau)$ with the following properties

- (1a) For $\tau \in [0, 1/3]$ the plane fields $\zeta'(\sigma, \tau)$ and $\xi(\sigma, 0)$ coincide on a neighborhood of $S^2 \times [-1, T_-(\xi(\sigma, 0))]$.
- (1b) For $\tau \in [3/4, 1]$ there is no change, i.e. $\zeta'(\sigma, \tau) = \zeta(\sigma, \tau)$ is a contact structure.
- (1c) For $\tau \in [1/2, 3/4]$: Let $\varphi_s(\sigma) : N \rightarrow N$, $s \in [0, 1]$, be family of diffeomorphisms of N fixing the boundary such that $\varphi_0 = \text{id}_N$ and

$$\varphi_1(\sigma) (S^2 \times [T_+(\zeta(\sigma, 3/4), 1)]) \text{ and } S^2 \times [-1, T_-(\zeta(\sigma, 0))]$$

are disjoint. Using the isotopy φ_s we define $\zeta'(\sigma, \tau)$ for $\tau \in [1/2, 3/4]$ as follows: For $\tau \in [1/2, 3/4]$ let

$$\zeta'(\sigma, \tau) = (\varphi_s)_* (\zeta(\sigma, 3/4)) \text{ with } s = 3 - 4\tau.$$

The second step is a deformation of the family $\zeta'(\sigma, \tau)$ such that the resulting plane field satisfies $\zeta''(\sigma, \tau) = \zeta'(\sigma, \tau)$ on the regions specified in the previous step, and the following additional requirement.

- (2) For $\tau \in [1/4, 1/2]$ we require that $\zeta''(\sigma, \tau) = \zeta'(\sigma, 1/2)$ on a neighborhood of $S^2 \times [T_+(\zeta'(\sigma, \tau), 1]$.

Both homotopies of plane fields exist by standard arguments from homotopy theory (notice that the union of the regions where we impose restrictions on ζ' and ζ' retracts onto $\partial(N \times I^2)$).

The diagram in Figure 13 indicates where $\zeta''(\sigma_0, \tau)$ is a contact structure for a fixed σ_0 .

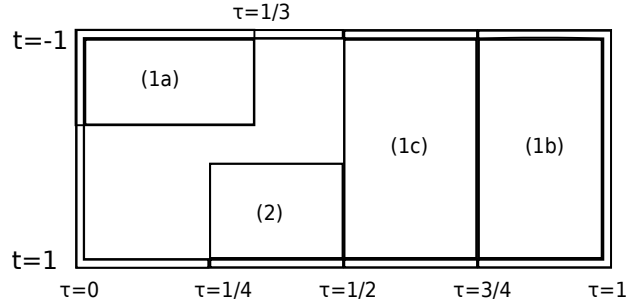

FIGURE 13. Domains in $\{\sigma = \sigma_0\}$ where ζ'' is contact by assumption (1a),(1b),(1c) and (2). Every line parallel to the t -axis represents $N \times \{(\sigma_0, \tau)\}$.

Deformation of $\zeta''(\sigma, \tau)$ to a family of contact structures $\xi(\sigma, \tau)$: By definition $\zeta''(\sigma, \tau)$ is a contact structure for $\tau \geq 1/2$. When $1/4 \leq \tau \leq 1/2$, the plane field $\zeta(\tau, \sigma)$ is an overtwisted contact structure on a collar of $S^2 \times \{1\}$ and there is a continuous family of overtwisted discs $\Delta(\sigma, \tau)$.

Finally, $\zeta''(\sigma, \tau)$ is an overtwisted contact structure on $S^2 \times [-1, T_-(\xi(\sigma, 0))]$ when $0 \leq \tau \leq 1/3$. Moreover, $\zeta''(\sigma, \tau)$ is independent of τ . In order to apply Theorem 2.5 it is therefore enough to construct a collection

$$\Delta_1(\sigma_1) \text{ for } \sigma_1 \in (s_0, s_1), \dots, \Delta_n(\sigma_n) \text{ for } \sigma_n \in (s_{n-1}, s_n)$$

of smooth families of overtwisted discs of $\zeta''(\sigma, 0) = \xi(\sigma, 0)$ such that

- they are pairwise disjoint in $N \times I \times \{0\}$,
- $\Delta_i(\sigma_i)$ is contained in a neighborhood of $S^2 \times [-1, T_-(\sigma_i, 0)] \times \{\sigma_i, 0\}$ where $\zeta''(\sigma_i, 0)$ is contact, and
- $(s_0, s_1) \cup \dots \cup (s_{n-1}, s_n) = (0, 1)$.

For this we use $T_-(\sigma, 0) < T_+(\sigma, 0)$ and the fact that $S^2(T_-(\sigma, 0), \sigma, 0)$ does not contain a locally non-loose minimal unknot for $\sigma \in (-1, 1)$ (c.f. the discussion on p. 32).

By definition, the characteristic foliation of $\zeta''(\sigma, 0) = \xi''(\sigma, 0)$ on $S^2(T_-(\sigma, 0), \sigma, 0)$ generically has

- a degenerate closed leaf,
- a single retrogradient connection, or
- a pair of simultaneous retrogradient connections.

In the first two cases we immediately obtain a pair of disjoint overtwisted discs on spheres $S^2(t, \sigma, 0)$ for $t = T_-(\sigma, 0) + \varepsilon$ for $\varepsilon > 0$ small enough. In the third case, because we have eliminated locally non-loose knots on $S^2(t, \sigma, 0)$, the same is true. These overtwisted discs correspond to stable configurations of leaves of the characteristic foliation, i.e. they are part of smooth families of overtwisted discs of $\zeta''(s, 0)$ lying on $S^2(T_-(s) + \varepsilon, s, 0)$ for s close enough to σ .

Note that $\zeta''(\sigma, 0)$ is already a contact structure for σ close enough to 0 or 1. Finally, since there is always a pair of disjoint overtwisted discs, we have found the desired collection of overtwisted discs.

According to Theorem 2.5 and the discussion following this statement, ζ'' is homotopic relative to the boundary to a I^2 -family of contact structures extending the ∂I^2 -family we started with (described in the table on p. 30).

Conclusion of the proof: The family of contact structures $\xi(\sigma, \tau)$, $\sigma, \tau \in I$, on N is constant near ∂N . According to Gray's theorem, there is a family of isotopies $\varphi_{\sigma, \tau}$ such that $(\varphi_{\sigma, \tau})_*(\xi(\sigma, 0)) = \xi(\sigma, \tau)$. The family of knots

$$(13) \quad \varphi_{\sigma, 1}^{-1}(\psi_\sigma(L))$$

is a family of Legendrian knots (parametrized by σ) in $(S^2 \times [-1, 1], \xi = \xi(\sigma, 0))$. Because the contact structure is independent of τ when $\sigma = 0$ or $\sigma = 1$, it follows that $\varphi_{0, \tau} = \text{id}_M = \varphi_{1, \tau}$. Therefore, the family of Legendrian knots in (13) interpolates between L and K . \square

Remark 3.11. In the previous proof, near $\tau = 1$, we perturbed a family of non-loose Legendrian unknots to obtain families of overtwisted discs. The choice involved here is a retrogradient connection which occurs first in the movie associated to a perturbation of the original family of spheres and the orientation of the knot.

Comparing the effect of the perturbation in the proof above with how a stabilization changes the characteristic foliation on a Seifert surface of the knot one sees, that the overtwisted discs could also have been obtained by stabilizing the non-loose unknot. Here one has to choose an orientation and the sign of the stabilization. The Legendrian unknots obtained in this way are isotopic to $K_{1,0}, K_{0,1}$ (cf. Section 2.5).

3.4. The classification up to isotopy for oriented unknots. All rigidity results in this article build on the following theorem.

Theorem 3.12. *Let K be a minimal non-loose unknot in S^3 . Then K and \overline{K} are not isotopic as oriented Legendrian knots.*

In order to prove Theorem 3.12 we will use two results. The first is concerned with the space of foliations by spheres of $S^2 \times [0, 1]$ and is based on Hatcher's theorem [Ha81] on the space of diffeomorphisms of $S^2 \times S^1$. The second result is more technical and uses standard theorems on transversality. It establishes that certain degenerate configurations of characteristic foliations on leaves of foliations by spheres occur on topologically tame subsets of the product of the leaf space with the parameter space.

3.4.1. *Foliations on $S^2 \times S^1$ and spheres containing a non-loose unknot.* We recall Hatcher's theorem on the homotopy type of $\text{Diff}(S^2 \times S^1)$ and conclude that the space of foliations on $S^2 \times [0, 1]$ which coincide with the product foliation near the boundary is weakly contractible. Recall also, that if one leaf of a foliation by orientable surfaces on a 3-manifold is a sphere, then all leaves are spheres (this famous result is due to G. Reeb).

Theorem 3.13 (Hatcher [Ha81]). *The map*

$$\begin{aligned} \text{O}(2) \times \text{O}(3) \times \Omega\text{SO}(3) &\longrightarrow \text{Diff}(S^2 \times S^1) \\ (A, B, \gamma_t) &\longmapsto ((p, \tau) \longmapsto (B \circ \gamma_\tau(p), A\tau)) \end{aligned}$$

is a weak homotopy equivalence.

Let $\text{Diff}_\partial(S^2 \times [0, 1])$ be the group of diffeomorphisms of $S^2 \times [0, 1]$ which coincide with the identity near the boundary and $\text{Diff}_\partial(S^2 \times [0, 1], \mathcal{F})$ the subgroup of those diffeomorphisms which preserve the product foliation. Theorem 3.13 implies that

$$\text{Diff}_\partial(S^2 \times [0, 1], \mathcal{F}) \longrightarrow \text{Diff}_\partial(S^2 \times [0, 1])$$

is a weak homotopy equivalence (see item (8) in the appendix of [Ha83] together with [Ha81]). By $\mathcal{FOL}_\partial(S^2 \times [0, 1])$ we denote the space of foliations on $S^2 \times [0, 1]$ which coincide with the product foliation near the boundary (we view foliations as plane fields to define the C^k -topology on $\mathcal{FOL}_\partial(S^2 \times [0, 1])$). The map

$$\begin{aligned} \text{Diff}_\partial(S^2 \times [0, 1]) &\longrightarrow \mathcal{FOL}_\partial(S^2 \times [0, 1]) \\ f &\longmapsto (f(S^2 \times \{t\}))_{t \in [0, 1]} \end{aligned}$$

is a Serre fibration whose fibers are homeomorphic to $\text{Diff}_\partial(S^2 \times [0, 1], \mathcal{F})$. This group can be thought of as $\Omega\text{SO}(3)$ (with the multiplication coming from the group structure on $\text{SO}(3)$). From Theorem 3.13 together with Smale's theorem stating that $\text{O}(3) \longrightarrow \text{Diff}(S^2)$ is a weak homotopy equivalence one obtains the following corollary.

Corollary 3.14. *The space $\mathcal{FOL}_\partial(S^2 \times [0, 1])$ is weakly contractible.*

3.4.2. *Degeneracies of characteristic foliations on spheres.* The second ingredient is a result on retrogradient connections present in the characteristic foliation on leaves of foliations or families of such foliations by spheres on $(S^2 \times [-1, 1], \xi)$. We assume that all singularities of characteristic foliations are isolated. When we consider families of foliations we still can parametrize each leaf space by $[-1, 1]$.

Let \mathcal{F} be a foliation from $\mathcal{FOL}_\partial(S^2 \times [0, 1])$ and assume that the leaf $S_{t_0}(\xi)$ contains a retrogradient connection. We parametrize a foliated neighborhood of this leaf by $S^2 \times (t_0 - \varepsilon, t_0 + \varepsilon)$ so that the foliation by the first factor coincides with the given foliation and fix a fiber T of $S^2 \times (t_0 - \varepsilon, t_0 + \varepsilon) \longrightarrow S^2 = S_{t_0}$.

Next, we will construct 1-parameter families of perturbations \mathcal{F}_x , $x \in (-\delta, \delta)$, with compact support in $S^2 \times (t_0 - \varepsilon, t_0 + \varepsilon) \setminus T$ and $\delta > 0$.

For $p \in \gamma$ choose a compactly supported Legendrian vector field X vanishing near T and outside of $S^2 \times [t_0 - \varepsilon, t_0 + \varepsilon]$ such that $X(p) \neq 0$ and X is positively transverse to the leaves of \mathcal{F} whenever it does not vanish.

Then the flow φ_x of X is well-defined. Let $\mathcal{F}_x := \varphi_x(\mathcal{F})$. By Lemma 2.20 there is still a retrogradient connection close to γ on nearby spheres $S_{\Gamma(x)}$ intersecting T

in $\Gamma(x)$ if $|x| < \delta$ is small enough. Let

$$\begin{aligned} \Gamma : (-\delta, \delta) &\longrightarrow (t_0 - \varepsilon, t_0 + \varepsilon) = T \\ x &\longmapsto \Gamma(x). \end{aligned}$$

The contact property of ξ ensures that t_0 is a regular value of Γ (c.f. the proof of Lemma 2.20 in [Gi00]).

We have described a perturbation for a fixed foliation \mathcal{F} but the construction can be carried out in the same way for finite dimensional families of characteristic foliations. Similar perturbations exist for degenerate singularities and connections between non-degenerate hyperbolic singularities of the same sign.

This type of perturbation can be applied simultaneously to different retrogradient connections and other degeneracies. Therefore, standard transversality theory (e.g. Theorem 2.7 in Chapter 3.2 of [Hi]) implies the following proposition:

Proposition 3.15. *Let $(N = S^2 \times [-1, 1], \xi)$ be a contact manifold with convex boundary and $\mathcal{F}_{\sigma, \tau}$, $\sigma, \tau \in (0, 1)$, a 2-parameter family of foliations on N which is constant near ∂N . Assume that the following conditions are satisfied for (t, σ, τ) outside of a compact set in $P = (-1, 1) \times (0, 1) \times (0, 1)$:*

- (i) *The subset of P consisting of points (t, σ, τ) where a non-degenerate retrogradient connection occurs on $S^2(t, \sigma, \tau)$ is a union of finitely many surfaces. Each retrogradient connection corresponds to one such surface. The analogous statement holds for degenerate singular points and connections between hyperbolic singular points which are not retrogradient. A degenerate singular point $p \in S^2(t, \sigma, \tau)$ is supposed to be of birth-death type. In particular, the index of p is zero and there is exactly one leaf γ_p of the characteristic foliation which is an unstable, respectively stable, leaf of p if p is negative, respectively positive.*
- (ii) *The set of points corresponding to connections of a degenerate singularity p to a hyperbolic singularity such that the connecting leaf is γ_p is a codimension 2 submanifold.*
- (iii) *Any two of the submanifolds from (i),(ii) intersect transversely and each of the submanifolds in (i) is transverse to the intersection of pairs of other submanifolds from (i). In particular, the points (t, p, σ) where $S^2(t, \sigma, \tau)$ has three retrogradient connections are isolated.*

After a C^r -small perturbation of $\mathcal{F}_{\sigma, \tau}$ relative to the complement of a small open neighborhood of the compact set these conditions are satisfied on P .

The fact that there are only finitely many singular points implies only that there are finitely many leaves of the characteristic foliations taking part in retrogradient connections. It does not mean that the space of instances, where a retrogradient connection occurs, is compact. For example, assume that $\xi(S_{t_0})$ has a closed leaf such that the holonomy is attractive on one side while it is repelling on the other. When a stable leaf of a positive hyperbolic singularity and an unstable leaf of a negative hyperbolic singularity accumulate on the degenerate closed leaf, then the set of leaves of a foliation by spheres containing S_{t_0} as a leaf, which contain a retrogradient connection, is non-compact.

3.4.3. Proof that K and \overline{K} are not isotopic. The proof of Theorem 3.12 is based on the following idea: We argue by contradiction. From a Legendrian isotopy from K to \overline{K} we construct a 2-parameter family (parametrized by $(\sigma, \tau) \in [0, 1]^2$)

of foliations $\mathcal{F}_{\sigma,\tau}$ by spheres on $S^2 \times [-1, 1]$ (each leaf space is parametrized by $t \in [-1, 1]$) such that

$$\mathcal{L} = \left\{ (t, \sigma, \tau) \in [-1, 1] \times [0, 1]^2 \mid \begin{array}{l} \text{the leaf } S^2 \times \{t\} \text{ of } \mathcal{F}_{\sigma,\tau} \text{ contains} \\ \text{a non-loose unknot} \end{array} \right\}$$

has the following properties:

- \mathcal{L} is a piecewise smooth submanifold of $[-1, 1] \times [0, 1]^2$ of codimension 2.
- \mathcal{L} is properly embedded in $[-1, 1] \times [0, 1]^2$.
- $\partial([-1, 1] \times [0, 1]^2)$ contains exactly one boundary point of \mathcal{L} .

Since compact 1-manifolds with boundary have an even number of boundary points, this is a contradiction. A slightly weaker claim on \mathcal{L} which would suffice is discussed briefly in the remarks following the proof of 3.12.

In the next example we consider one configuration where the sphere $S^2(t_0, \sigma_0, \tau_0)$ contains three simultaneous retrogradient connection. Our goal is to understand how this can lead to \mathcal{L} being a non-smooth submanifold of $[-1, 1] \times [0, 1]^2$. Recall Corollary 3.4 which will be used frequently to establish the existence of minimal non-loose unknots.

Example 3.16. The top diagram of Figure 14 represents three non-degenerate retrogradient connections on $S^2(t_0, \sigma_0, \tau_0)$ (as explained on p. 26). We assume that $p_0 = (t_0, \sigma_0, \tau_0) \in \mathcal{L}$ lies in the interior of P . The graph $\Gamma_{t,-}$ is a closed (as subset) tree for $t \in (t_0 - \varepsilon, t_0)$ and $t \in (t_0, t_0 + \varepsilon)$ for $\varepsilon > 0$ small enough. We consider which points of

$$\mathcal{L}_{\text{gen}} = \left\{ (t, \sigma, \tau) \in \mathcal{L} \mid \xi(S^2(t, \sigma, \tau)) \text{ has exactly two retrogradient connections} \right\}$$

can lie in a neighborhood of p_0 .

Points $(t_{\text{double}}, \sigma, \tau)$ of \mathcal{L}_{gen} which are close enough to (t_0, σ_0, τ_0) have two simultaneous retrogradient connections, and the remaining third bifurcation also occurs in the movie on $N \times \{(\sigma, \tau)\}$, but at a time t_{single} which is different from t_{double} .

For $(t_{\text{double}}, \sigma, \tau) \in \mathcal{L}_{\text{gen}}$ it is necessary (and also sufficient by Corollary 3.4), that no overtwisted disc appears on a sphere S_t^2 in the movie $N \times \{(\sigma, \tau)\}$ for $t \neq t_{\text{double}}$. In Figure 14 we consider all possibilities: The column on the left schematically shows $\Gamma_{t,-}$ for $t_{\text{single}} < t < t_{\text{double}}$, when the single bifurcation occurs before the two simultaneous retrogradient connections. $\Gamma_{t,-}$ is the union of solid and dashed arcs while dotted arcs indicate the bifurcation which happens later at t_{double} . Note that in all three cases, $\Gamma_{t,-}$ is not a tree, i.e. there is an obvious overtwisted disc. Hence, none of these resolutions of the threefold retrogradient connection into a single retrogradient connection occurring *before* a double retrogradient connection corresponds to points of \mathcal{L}_{gen} .

The column on the right shows $\Gamma_{t,-}$ when $t_{\text{double}} < t < t_{\text{single}}$. Here, there is only the resolution (marked with *AB first, then C*) of the threefold retrogradient connection into a single retrogradient connection occurring *after* a double retrogradient connection leads to $\Gamma_{t,-}$ not being a tree for $t \in (t_{\text{double}}, t_{\text{single}})$. The other two resolutions correspond to points in \mathcal{L}_{gen} .

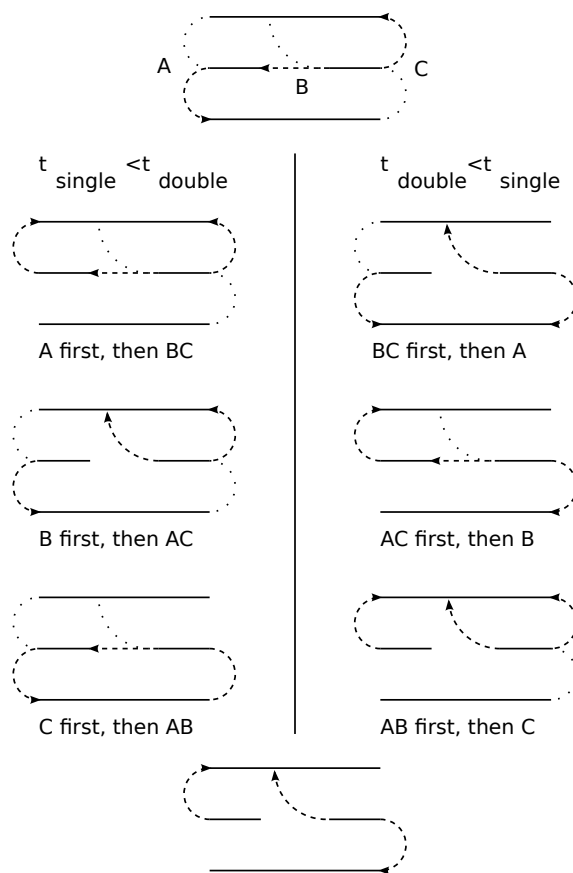

FIGURE 14. Three simultaneous retrogradient connections and possible resolutions with a pair of simultaneous retrogradient connections.

Hence, p_0 is a non-smooth point of \mathcal{L} , but it has a neighborhood where \mathcal{L} is a topological submanifold of $(-1, 1) \times (0, 1)^2$. In particular, it is not a boundary point of \mathcal{L} .

Figure 15 represents a neighborhood of p_0 in P . Points on planes marked with A, B, C correspond to spheres where the retrogradient connection A, B, C occurs. The intersection point of all three planes is p_0 . The t -axis is supposed to be horizontal, and by Lemma 2.20 the planes have to be transverse to this direction. Intersections between two planes (dashed and dotted lines) correspond to two retrogradient connections occurring on the same sphere. The thickened dashed segments are contained in \mathcal{L} .

Configurations similar to the one considered in this example will appear later.

The following preparatory lemma yields a normalization of the characteristic foliation on a sphere containing a non-loose unknot.

Lemma 3.17. *Let $K_\sigma \subset S^3, \sigma \in [0, 1]$, be a family of non-loose Legendrian unknots with $\text{tb}(K_\sigma) = 1$ and $K_1 = K_0$. Then there are two balls $B_0, B_1 \subset S^3$ and a family of foliations \mathcal{F}_σ of $S^3 \setminus (B_0 \cup B_1)$ by spheres such that*

- $\mathcal{F}_0 = \mathcal{F}_1$,

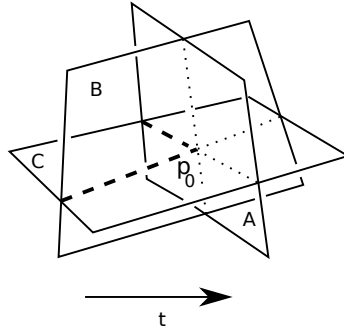
FIGURE 15. A non-smooth point in \mathcal{L}

- K_σ is contained in a leaf S_σ of \mathcal{F}_σ , and
- the characteristic foliation on S_σ has exactly two singularities along K_σ .

Proof. The family of knots $K_\sigma, \sigma \in [0, 1]$, misses two small balls B_0, B_1 which we assume to be Darboux balls with convex boundary. We choose a sphere \mathcal{F}_0 with the desired properties such that S_0 is a leaf carrying K_0 such that the characteristic foliation is in normal form.

By Gray's theorem we can choose a contact isotopy ψ_σ of S^3 with support on the complement of $B_0 \cup B_1$ so that $\psi_\sigma(K_0) = K_\sigma$, and we consider $\mathcal{F}'_\sigma = \psi_\sigma(\mathcal{F}_0)$. This is a family of foliations with all desired properties except that $\mathcal{F}_0 = \mathcal{F}'_0 \neq \mathcal{F}'_1$ in general.

Let $S'_1 = \psi_1(S_0)$ and α, α' functions on the universal cover $\text{pr} : \tilde{K}_0 \rightarrow K_0$ of $K_0 = K_1$ such that $\alpha(p)$, respectively $\alpha'(p)$, is the angle between $\xi(\text{pr}(p))$ and S_0 respectively S'_1 . Both functions attain each of the values $\dots, -\pi, 0, \pi, 2\pi, \dots$ exactly once. They are homotopic through functions with this property to strictly monotone functions α_m, α'_m . There is a homotopy between these two functions through strictly monotone functions. Twisting S'_1 around K_0 accordingly, we obtain an isotopy moving S'_1 to S''_1 keeping K_1 fixed such that S''_1 and S_0 coincide on a tubular neighborhood of K_1 and such that throughout the isotopy the characteristic foliation on the sphere has exactly two singular points along $K_0 = K_1$.

As in the proof of the Roussarie-Thurston normal form [Ro] for surfaces in 3-manifolds carrying a Reebless foliation one can isotope S''_1 so that it coincides with S_0 after the isotopy. From Corollary 3.14 we obtain the desired family of foliations \mathcal{F}_σ . \square

Finally, we are in a position to prove Theorem 3.12.

Proof of Theorem 3.12. Assume that $K_\sigma, \sigma \in [0, 1] = I$, is a family of oriented Legendrian knots in (S^3, ξ) such that $K_0 = K$ and $K_1 = \overline{K}$. This isotopy avoids two points of S^3 , and we can therefore consider S^3 with two small open balls removed. We denote this space by $N \simeq S^2 \times [-1, 1]$.

We will consider $N \times I^2$, and as in the proof of Theorem 3.10 the product decomposition of N will vary.

- For $\tau = 0$ we choose an identification of N with $S^2 \times [-1, 1]$ such that $S = S^2 \times \{0\}$ contains K . We require that the characteristic foliation of ξ on S is in standard form (c.f. Theorem 3.2).

- For $\sigma = 0$ and $\sigma = 1$ we consider the same identification of N with $S^2 \times [-1, 1]$.
- When $\tau = 1$ we choose a family of spheres S_σ such that
 - $K_\sigma \subset S_\sigma$, and
 - S_0 and S_1 coincide with the sphere $S^2 \times \{0\}$ from the identifications chosen above.
- Now we extend S_σ to a family of smooth foliations by spheres on N such that S_σ is a leaf on the foliation $N \times \{(\sigma, \tau = 1)\}$. By Lemma 3.17 we may assume that the characteristic foliation of ξ on S_σ has exactly two singular points along K_σ .

This fixes the boundary conditions. The vertical dashed line in Figure 16 in the back face $\tau = 0$ corresponds to a constant family of Legendrian knots K while the thickened curve on the front face $\{\tau = 1\}$ represents the family K_σ .

In the next step we perturb the family of spheres in a particular way on a neighborhood of $S^2 \times \partial([-1, 1] \times I^2)$.

On each sphere $S^2 \times [-1, 1] \times \{(\sigma, \tau)\}$ with $(\sigma, \tau) \in \partial I^2$ containing the non-loose unknot K_σ , starting with $\tau = 1$ and $\sigma = 1/2$, we consider the retrogradient connection $\gamma_{\sigma, \tau}$ whose orientation coincides with the orientation of the Legendrian knot as one moves along ∂I^2 .

Because K_0 and K_1 have different orientations, the retrogradient connection one obtains after returning to $\tau = 1, \sigma = 1/2$ for the first time is opposite to the one has started with.

For each point $(\sigma, \tau) \in \partial(I^2)$ we choose a small deformation of the family of spheres as follows:

- For the point $(\sigma = 1/2, \tau = 1)$ the family of spheres is unchanged.
- For all other points the deformation is constructed as follows. Fix a small disc $D_{\sigma, \tau}$ intersecting the retrogradient connection chosen above (but not the other) such that the characteristic foliation of ξ on $D_{\sigma, \tau}$ has no singular points. To obtain the deformation we push the interior of the small discs slightly into the direction given by the coorientation of the spheres (and extending this deformation to nearby spheres).

As (σ, τ) approaches $(\sigma = 1/2, \tau = 1)$, the size of the deformation converges to zero (with respect to every C^r -norm, $1 \leq r \in \mathbb{Z}$), so that we obtain a family of deformations depending smoothly on (σ, τ) .

Sufficiently small deformations as above do not introduce new singular points of the characteristic foliation on the deformed spheres and the retrogradient connections which formed the non-loose unknot before the deformation now appear on two different spheres (c.f. the discussion at the end of Section 3.1) except for $\sigma = 1/2$ and τ close to 1.

We use these deformations to extend the family of spheres from ∂I^2 to a neighborhood of ∂I^2 in I^2 . By construction the retrogradient connections on $N \times \{\sigma, \tau\}$ for (σ, τ) in the interior of I^2 occur on different spheres except for $\sigma = 1/2$ and τ close to 1. These are represented by the thickened dashed lines in Figure 16.

According to Corollary 3.14 we can extend the family of foliations by spheres on N we have constructed for parameter values in a neighborhood of I^2 to the entire parameter space I^2 . As usual, the spheres are parametrized by three parameters: $t \in [-1, 1]$ and $(\sigma, \tau) \in I^2$, and we assume that the singularities of the characteristic foliations of ξ on these spheres of ξ are isolated.

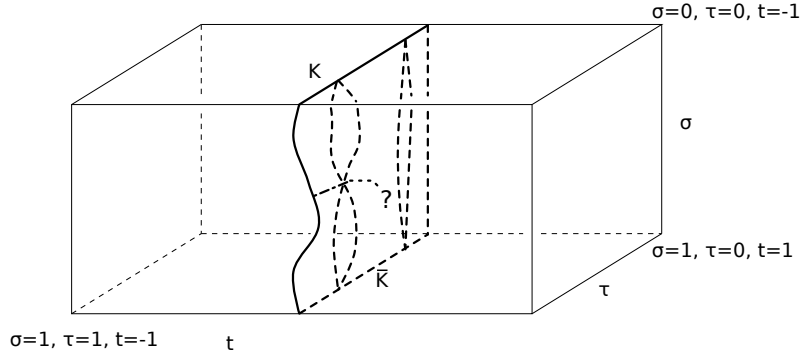

FIGURE 16. Germ of a 1-manifold obtained from an orientation reversing isotopy of K

We now consider the set \mathcal{L} of those parameter values (t, σ, τ) for which the corresponding sphere contains a non-loose piecewise smooth Legendrian unknot.

Claim: \mathcal{L} is a piecewise smooth properly embedded submanifold of codimension 2 whose boundary is contained in $\partial([-1, 1] \times I^2)$.

Before proving the claim, note that it implies the theorem since each submanifold component contributes an even number of boundary points. However, there is only one boundary point of \mathcal{L} in $\partial([-1, 1] \times I^2)$.

Proof of the claim: By Proposition 3.15 we may assume that the points in $(-1, 1) \times (0, 1)^2$ where the corresponding characteristic foliation has exactly two retrogradient connections is a codimension-2 submanifold. We denote the set of these generic points in \mathcal{L} by \mathcal{L}_{gen} . Points where \mathcal{L} might not be a smooth submanifold are

- (1) points where three retrogradient connections occur simultaneously,
- (2) points where one singularity of the characteristic foliation which is a limit point of a retrogradient connection is degenerate, and
- (3) points where two retrogradient connections occur and there is an additional connection between two hyperbolic points.

All these degenerations occur in isolated points of $(-1, 1) \times I^2$ by Proposition 3.15 and more degenerate situations do not occur at all.

In the following we treat the cases (2) and (3). After that we will show that \mathcal{L} is compact and it turns out that all limit configurations of \mathcal{L}_{gen} with three retrogradient connections can be treated in the same way as in Example 3.16.

Let us now consider a sphere $S^2(t_0, \sigma_0, \tau_0)$ which contains a minimal non-loose unknot such that one of the singularities of the characteristic foliation, which is a limit point of a retrogradient connection, is degenerate. We will assume that this singularity is negative. This situation was already discussed in Remark 3.6 on p. 25.

The following considerations deal with a sufficiently small neighborhood of $p_0 = (t_0, \sigma_0, \tau_0)$ in the parameter space. By our genericity assumptions, the degenerate singularity has index 0 and it is of birth-death type. In particular, the set

$$\mathcal{S} = \{(t, \sigma, \tau) \mid \xi(S^2(t, \sigma, \tau)) \text{ has a degenerate singularity}\}$$

is a submanifold near p_0 . According to Remark 3.6, S separates two surfaces defined by the presence of a retrogradient connection A and A' which involve the same stable leaf of a hyperbolic positive singularity of $\xi(S^2(t, \sigma, \tau))$ for (t, σ, τ) close to p_0 . While A' defines a surface, A determines a surface with boundary. This boundary is contained in the closure of the surface corresponding to A' and it is also contained in S . Moreover, it is smooth. The other retrogradient connection B is not affected by the degeneracy of the singular point and in general position (in a neighborhood of p_0) with respect to all subspaces of the parameter space mentioned so far (in particular to the boundary of A where a retrogradient connection is degenerate).

This implies that \mathcal{L} is a piecewise smooth submanifold of P of codimension 2 near p_0 . The left-hand side of Figure 17 depicts the situation we have considered. The plane containing the thickened lines marked with S consists of those points in P for which the corresponding characteristic foliation has a degenerate singularity.

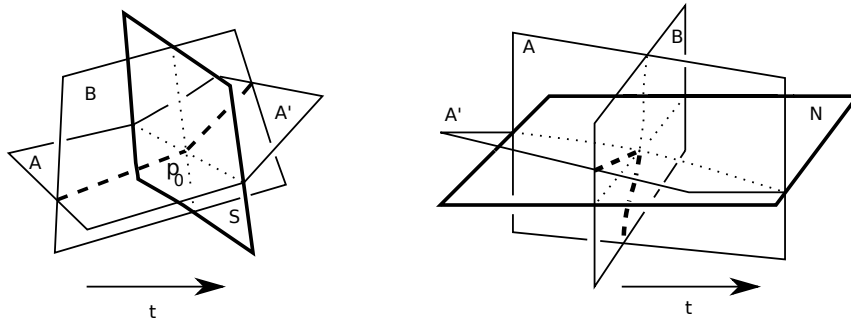

FIGURE 17. Non-smooth points of \mathcal{L}

Similar considerations apply in the case when $\xi(S(p_0))$ has exactly two retrogradient connections and another connection γ between two hyperbolic singularities x, y of the same sign. We assume that x, y are negative.

We consider the one of the configurations for which one has to appeal to transversality and which leads to a non-smooth point in \mathcal{L} . The other cases are analogous. Assume that

- (i) an unstable leaf of x is one of the retrogradient connections,
- (ii) γ is a stable leaf of x , and
- (iii) the other retrogradient connection B is connected to y using a path in Γ_-^* which does not pass through x .

Let z be the positive singularity at the end of the retrogradient connection which is opposite to x and U a neighborhood of $p_0 \in (-1, 1) \times (0, 1)^2$. Since all singular points are non-degenerate x, y , respectively γ are part of a families of hyperbolic singularities respectively unstable leaves of a hyperbolic singularity defined on U . Let N be the local hypersurface such that for parameters values in U the leaf γ connects y to x .

We choose U so small that $U \setminus N$ has two connected components. In one of these components there are always precisely two retrogradient connections A, B . When A, B occur on the same sphere, then there is a non-loose unknot on that

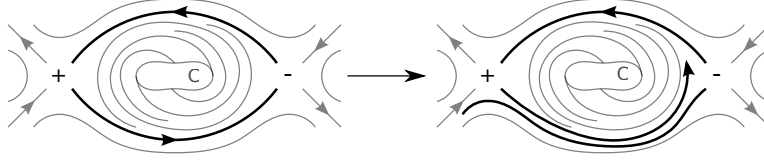

FIGURE 18. Perturbations of cycles with one-sided holonomy result in overtwisted discs.

sphere. This knot is formed by a path containing the two retrogradient connections and paths in the components $\Gamma'_- \subset \Gamma^*$ and $\Gamma'_+ \subset \Gamma^*$ which satisfy $e_{\pm}(\Gamma'_{\pm}) + 1 = h_{\pm}(\Gamma'_{\pm})$ (see Definition 3.3 on p. 23).

By Lemma 2.20 there is one additional 2-parametric family of parameter values $p \in U$ such that there is a retrogradient connections A' from y to z . The retrogradient connection A (from x to z) and A' (from y to z) never occur on the same sphere. Because of assumption (iii), a non-loose unknot is now formed when the retrogradient connections A' and B occur simultaneously (c.f. the right-hand side in Figure 17) but not when A and B appear on the same sphere. Note that of (iii) is not satisfied, then p_0 is a smooth point of \mathcal{L} defined by the intersection of the surfaces corresponding to A and B .

In order to finish the proof of the claim it remains to show that \mathcal{L} is a *compact* piecewise smooth submanifold.

Let S_n be a sequence of leaves of $\mathcal{F}_{\sigma_n, \tau_n}$ containing a minimal non-loose Legendrian knot K_n . We may assume that

- S_n converges to a sphere S_{∞} (we denote the corresponding parameter values by $t_{\infty}, \sigma_{\infty}, \tau_{\infty}$) of $\mathcal{F}_{\sigma_{\infty}, \tau_{\infty}}$.
- K_n converges to a union \mathcal{K} of leaves of $\xi(S_{\infty})$ which is a closed subset of S_{∞} .

Since we understand \mathcal{L} near the boundary of $[-1, 1] \times I^2$ we are only interested in the case when the limit point $(t_{\infty}, \sigma_{\infty}, \tau_{\infty})$ lies in the interior of $[-1, 1] \times I^2$.

\mathcal{K} cannot contain a non-degenerate closed leaf since every sphere close enough to S_{∞} contains closed leaf contradicting the fact that K_n is non-loose. For degenerate closed leaves Lemma 2.21 asserts that for $t > t_{\infty}$ or $t < t_{\infty}$ the sphere $S(t, \sigma_{\infty}, \tau_{\infty})$ contains an attractive closed leaf. This prevents the existence of non-loose unknots in spheres close to S_{∞} . We may therefore assume that $\xi(S_{\infty})$ has no closed leaf.

If S_{∞} contains a cycle (made from stable and unstable leaves of hyperbolic singularities) with one sided holonomy, then after an isotopy of S_{∞} which moves S_{∞} into its complement the characteristic foliation on the isotoped sphere contains an overtwisted disc. This does not require any assumption on the signs singular points on the cycle and uses only the Poincaré-Bendixson theorem: If γ is the cycle and C a closed curve transverse curve such that C and γ bound an annulus, then a perturbation as in Figure 18 makes a closed leaf appear.

This contradicts $(t_{\infty}, \sigma_{\infty}, \tau_{\infty})$ being the limit of parameter values corresponding to spheres containing non-loose unknots. Therefore, S_{∞} does not contain any limit cycles with one sided holonomy and all leaves of $\xi(S_{\infty})$ have singular points as limit sets.

Let Γ_-^* be the graph consisting of negative singularities of the characteristic foliation on S_∞ and their unstable leaves which do not take part in retrogradient connections. If a connected component of Γ_-^* is not a tree, then $N \setminus S_\infty$ contains overtwisted discs. This is a contradiction to the fact that there are non-loose unknot arbitrarily close to S_∞ .

By construction, S_∞ contains at least two retrogradient connections and the complement $N \setminus S_\infty$ is tight. Assume that S_∞ contains exactly two retrogradient connections. Then Γ_-^* has three connected components. If each of these components takes part in at most one retrogradient connection, then one can eliminate all hyperbolic singularities on S_∞ using Lemma 2.22:

Let $S_\infty \times [\delta, \delta]$, $\delta > 0$, be a tubular neighborhood of S_∞ such that the characteristic foliation on each boundary sphere of this neighborhood has only two elliptic singularities. Then one can deform the contact structure on $N \times \{\sigma_\infty, \tau_\infty\}$ so that

- nothing changes away from $N \times (-\delta, \delta)$, and
- the characteristic foliation on $S_\infty \times \{s\}$ for $s \in (-\delta, \delta)$ never has hyperbolic points after the deformation.

Then S_∞ has a tight neighborhood and ξ itself would be tight. Therefore, there is one component of Γ_- which takes part in both retrogradient connections and the same is true for Γ_+ (consisting of positive singular points and their stable leaves). The union of these two components contains a non-loose Legendrian unknot whose Thurston-Bennequin invariant is one.

Assume now that the limit sphere $S^2(t_\infty, \sigma_\infty, \tau_\infty)$ contains three retrogradient connections. Since points of \mathcal{L}_{gen} lie arbitrarily close to $(t_\infty, \sigma_\infty, \tau_\infty)$, this configuration is obtained from a pair of simultaneous retrogradient connections A, B as in the top part of Figure 7 (on p. 24) by adding a third retrogradient connection C such that the associated negative hyperbolic singularities lies on one component of $\Gamma_-(t_\infty)$ with the unstable leaves which take part in A, B removed.

Some configurations obtained in this way are less interesting than others: For example, the case when the new retrogradient connection is trivial in the sense that the bifurcation does not affect which components of Γ_-^* are connected directly through unstable leaves in $\Gamma_- \setminus \Gamma_-^*$ (as in the left-hand part of Figure 19) corresponds to smooth points of \mathcal{L} . We also do not have to consider the case when the new retrogradient connection (i.e. the one different from A, B) leads to obvious overtwisted discs which are not affected by A or B (as in the right-hand part of Figure 19). Finally, note that Lemma 2.20 restricts the possible bifurcations.

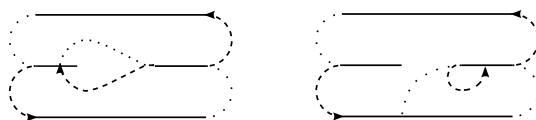

FIGURE 19. Simple examples of configurations with three retrogradient connections.

Up to combinatorial equivalence (rotating a diagram by 180°) all remaining possibilities are listed in Figure 20 on p. 46. Two of these (left column in the middle and right column at the bottom) cannot appear as limit points $(t_\infty, \sigma_\infty, \tau_\infty)$ of \mathcal{L}_{gen}

because there are obvious overtwisted discs on $S^2 \times \{t\} \times \{\sigma_\infty, \tau_\infty\}$ for $t > t_\infty$ or $t < t_\infty$. The top left configuration was analyzed in Example 3.16, the remaining three configurations can be treated in the same fashion.

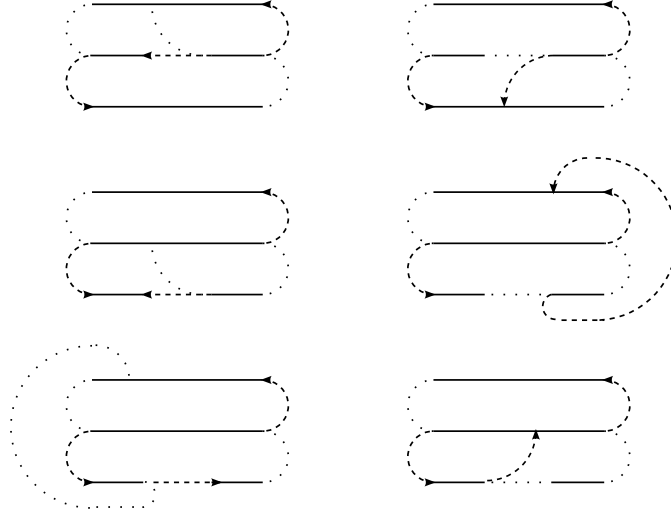

FIGURE 20. Remaining configurations with three simultaneous retrogradient connections.

We have dealt with the case when the characteristic foliation on $S^2(t_\infty, \sigma_\infty, \tau_\infty)$ contains a degenerate singularity or one additional non-retrogradient connection between hyperbolic singular points. Therefore, \mathcal{L} is a piecewise smooth submanifold of codimension 2 in $[-1, 1] \times I^2$ which is compact and properly embedded. \square

Let us discuss two aspects of the above proof:

- (1) All configurations with three retrogradient connections in $\overline{\mathcal{L}}_{gen}$ have the following property: Γ_-^* consists of four connected components and one of them is obtained by splitting one of the components of the analogous graph for a minimal non-loose unknot with two retrogradient connections into two pieces. Using the normal form from Theorem 3.2 for a minimal non-loose unknot one sees that one of the components Γ' of Γ_-^* satisfies $e_-(\Gamma') = h_-(\Gamma')$.

Since this component is a tree, one can eliminate Γ' completely by Lemma 2.22 without creating closed leaves. In particular, one of the three retrogradient connections on S_∞ disappears and no new triples of simultaneous retrogradient connection appear (use Lemma 2.15 in [Gi00]). A similar argument can be used in the above proof for degeneracies of type (3).

This argument only shows that \mathcal{L} is piecewise smooth after an additional operation on the foliation by spheres. Of course, this would suffice for our purposes.

- (2) We did not show that there is a *continuous* (in the Hausdorff topology) family of non-loose unknots $K(x)$ with $x \in \mathcal{L}$.

The argument used in the previous proof can be used to show the following, very similar, result. In the refereeing process it was pointed out to the author that the claim of the following theorem goes back to Y. Chekanov. Unfortunately, there seems to be no printed reference.

Before we state the theorem, we fix the setup. Let K be a non-loose unknot in (S^3, ξ_{-1}) with some orientation. We denote the unknot obtained as positive stabilization of K by Δ , K with reversed orientation is \overline{K} and the positive stabilization of \overline{K} is $\widehat{\Delta}$. Note that $\Delta, \widehat{\Delta}$ are unknots with vanishing Thurston-Bennequin invariant and $\text{rot}(\Delta) = \text{rot}(\widehat{\Delta}) = 1$.

Theorem 3.18 (Chekanov). *$\widehat{\Delta}$ is not isotopic to Δ .*

Proof. Assume that there is an isotopy φ_σ of S^3 which moves Δ to $\widehat{\Delta}$. As in the previous proof $\varphi_\sigma(\Delta), \sigma \in I = [0, 1]$, misses two balls which we assume to be so small that they are contained in Darboux domains and have convex boundary. The complement of these balls is $N \simeq S^2 \times [-1, 1]$. We reconsider the setting of the proof of Theorem 3.12. On $N \times I^2$ we consider the restriction of ξ_{-1} to N on all $N \times \{\sigma, \tau\}$. We fix a family of foliations $\mathcal{F}_{\sigma, \tau}, \sigma, \tau \in I$ by spheres on N so that

- $\mathcal{F}_{\sigma, \tau}$ is constant near ∂N ,
- a sphere of $\mathcal{F}_{\sigma=0, \tau=1}$ contains Δ ,
- $\mathcal{F}_{\sigma, 1} = \varphi_\sigma(\mathcal{F}_{0, 1})$,
- $\mathcal{F}_{0, \tau}, \mathcal{F}_{1, \tau}$ is independent of τ ,
- on $N \times \{\sigma, \tau = 0\}$ we pick a family of foliations interpolating between $\mathcal{F}_{\sigma=0, 0}$ and $\mathcal{F}_{\sigma=1, 0}$ (already fixed) as follows: a leaf of $\mathcal{F}_{1/2, 0}$ contains a non-loose unknot K . To obtain $\mathcal{F}_{\sigma, 0}$ for $\sigma \leq 1/2$ and $\sigma \geq 1/2$ first deform $\mathcal{F}_{1/2, 0}$ to make overtwisted discs appear which are isotopic to Δ , respectively $\widehat{\Delta}$, for $\sigma < 1/2$, respectively $\sigma > 1/2$, and use the isotopy to extend the given family of foliations to a family of foliations for $(\sigma, \tau) \in \partial(I^2)$ such that precisely one leaf of one foliation contains a non-loose unknot (namely K on a leaf of $\mathcal{F}_{1/2, 0}$).

As in the proof of Theorem 3.12 one shows that such a configuration is not possible contradicting the assumption that Δ is isotopic to $\widehat{\Delta}$. \square

The above theorem can be rephrased: The identity component of $\text{Diff}_+(S^3, \xi_{-1})$ does not act transitively on the set of boundaries of overtwisted discs.

Finally, we note the following corollary of the proof of Theorem 3.10. This corollary, or a statement equivalent to it, must have been known to Y. Chekanov (see Theorem 4.4 below).

Corollary 3.19. *Let $\psi \in \text{Diff}_+(S^3, \xi_{-1})$ such that $d(\psi) = 0$ and $\psi(K)$ is isotopic to K as oriented Legendrian knot. Then ψ is isotopic to the identity through contact diffeomorphisms.*

Proof. We may assume that ψ fixes two disjoint Darboux balls and that $\psi(K)$ is isotopic to K in the complement N of these balls. There is a smooth isotopy $\psi_\sigma, \sigma \in I$, with $\psi_1 = \psi$ and $\psi_0 = \text{id}$ which does not move the two Darboux balls.

Now apply the construction of the proof of Theorem 3.10. For this we fix contact structures $\xi(\sigma, \tau)$ and product decompositions of N for $(\sigma, \tau) \in \partial I^2$ as in the proof of Theorem 3.10. Since $\psi(K)$ is isotopic to K through Legendrian knots in $N \times I \times \{\tau = 0\}$. Therefore we can perturb the product decompositions of N near

$\{\tau = 0\}$ and $\{\tau = 1\}$ so that $T_+(\sigma, \tau) \neq T_-(\sigma, \tau)$ for $t \notin \{0, 1\}$ or $\sigma \notin \{0, 1\}$. (Recall that the assumption that K is isotopic to \overline{K} led points (σ, τ) in near ∂I^2 where $T_+(\sigma, \tau) = T_-(\sigma, \tau)$ in the proof of Theorem 3.12.)

Since $d(\psi) = 0$, the proof of Theorem 3.10 yields a deformation of the smooth isotopy ψ_σ from id to ψ into a contact isotopy relative to ψ_0 and ψ_1 . \square

4. APPLICATIONS

We give the proof of a theorem of Y. Chekanov about the contact mapping class group of overtwisted contact structures on S^3 . The proof of that theorem also requires further results on the action of the contactomorphism group on boundaries of overtwisted discs, these will be discussed first.

We conclude with the classification of Legendrian unknots in overtwisted contact structures on S^3 . So far, we were mostly concerned with minimal non-loose unknots.

4.1. The action of contactomorphisms on the set of boundaries of overtwisted discs. It is an easy corollary of Eliashberg's classification result that the group of all contactomorphisms of an overtwisted contact structure ξ acts transitively on the set $\mathcal{U}_0(\xi)$ of Legendrian unknots with vanishing Thurston-Bennequin invariant and rotation number one. In this section we will show that the connected component of the identity of $\text{Diff}_+(S^3, \xi_{-1})$ does act transitively on $\mathcal{U}_0(\xi_k)$ when $k \neq -1$.

Lemma 4.1. *Let (M, ξ) be a contact manifold and $\Delta \in \mathcal{U}_0$. Then there is a Lutz tube along a transverse unknot with self-linking number -1 containing Δ such that the Lutz tube is contained in a ball whose boundary is convex and has a tight neighborhood. If the π -Lutz twist is undone, then the contact structure becomes tight on the ball.*

π -Lutz twists as in this lemma will be called simple.

Proof. First of all, note that one can choose a convex disc D bounding Δ such the dividing set on D is connected. In order to see this consider any convex disc D bounding Δ , fix an overtwisted disc D' in the complement of D and construct a contact structure with the desired properties using Theorem 2.5. For this one uses assumption that $\text{rot}(\Delta) = 1$.

Now consider a plane field ζ on M which is homotopic to ξ satisfying the following conditions.

- $\zeta = \xi$ near Δ .
- $\zeta = \xi$ near D' .
- ζ is a contact structure on a closed ball B^3 such that
 - B^3 is disjoint from D' and contains D in its interior,
 - the boundary of B^3 is convex with respect to ζ and the dividing set on ∂B^3 is connected, and
 - $\zeta|_{B^3}$ is obtained from the tight contact structure determined by $\zeta(\partial B^3)$ by a single π -Lutz twist along a transverse unknot and D is one of the obvious overtwisted discs obtained from a π -Lutz twist.
- ζ is homotopic to ξ as a plane field.

According to Theorem 2.5 ζ is homotopic to a contact structure and ζ is isotopic to ξ relative to a neighborhood of Δ (one uses the overtwisted disc D' for the application of Theorem 2.5), so we can assume that ζ itself is a contact structure.

The ball with the desired properties is obtained from B^3 and the contact structure ζ using the fact that ξ and ζ are isotopic contact structures. \square

The last lemma allows us to establish a contact topological (rather than homotopy theoretic) criterion, which distinguishes ξ_{-1} from those positive overtwisted contact structures on S^3 which are not diffeomorphic to ξ_{-1} .

Proposition 4.2. *Let ξ be an overtwisted contact structure on S^3 . Then ξ is isotopic to ξ_{-1} if and only if there is a closed ball $B^3 \subset M$*

- which contains a simple Lutz tube,
- ∂B^3 has a tight neighborhood, and $S^3 \setminus B^3$ is tight.

Proof. First, note that according to the description of ξ_{-1} outlined in Example 2.37 this contact structure is obtained from the tight contact structure on S^3 by a single Lutz twist along a transverse unknot with self-linking number -1 . Thus, there is a ball containing that Lutz twist whose complement is tight.

Conversely, if there is ball with tight complement and convex boundary who contains a simple Lutz twist in its interior, then undoing the Lutz twist on B^3 we obtain a tight contact structure on B^3 . By Colin's gluing theorem [Co97] undoing the Lutz twist yields a tight contact structure on S^3 . In other words, ξ is obtained from the tight contact structure on S^3 by a single π -Lutz twist. Then ξ is homotopic to (and hence isotopic) to ξ_{-1} . \square

This has the following consequence.

Theorem 4.3. *Let ξ be an overtwisted contact structure on S^3 which is not isotopic to ξ_{-1} . Then for every pair $\Delta_1, \Delta_2 \in \mathcal{U}_0(\xi)$ there is an overtwisted disc Δ which is disjoint from $\Delta_1 \cup \Delta_2$.*

Proof. According to Lemma 4.1 we may assume that Δ_1 is obtained by a π -Lutz twist along a transverse unknot in a tight ball B^3 with convex boundary. By Proposition 4.2, the complement of this ball is overtwisted.

We will use a certain procedure to attempt to isotope Δ_2 relative to Δ_1 so that the result lies in the union of B^3 with a neighborhood V of B^3 such that $\bar{V} \setminus \overset{\circ}{B}^3$ is tight. According to [Co97] the complement of V (and not only the complement of B^3) contains an overtwisted disc. The process described below either works or not.

If this procedure works, then there is an overtwisted disc in $S^3 \setminus V$, i.e. in the complement of a link which is Legendrian isotopic to $\Delta_1 \cup \Delta_2$. This implies the result in this case.

It will turn out that if the procedure does not work, then this is due to the presence of an overtwisted disc in $S^3 \setminus V$ which is disjoint from a link which is Legendrian isotopic to $\Delta_1 \cup \Delta_2$. Again, the result follows.

Let \widehat{D} be a disc bounding Δ_2 . Without loss of generality we assume that Δ_2 and \widehat{D} are transverse to ∂B^3 . There is a disc $D \subset \widehat{D} \setminus \overset{\circ}{B}^3$ such that

- the interior of D is disjoint from Δ_2 , $\xi|_{\delta_2} = T\widehat{D}|_{\delta_2}$, and
- ∂D is the union of an arc $\delta_2 \subset \Delta_2$ with an arc $\delta_B \subset D \cap \partial B^3$.

After an isotopy of D relative to δ_2 we obtain a disc D' with piecewise smooth Legendrian boundary such that $\delta'_2 = \partial D' \setminus \delta_2$ is contained in a tubular neighborhood V' of ∂B^3 where ξ is tight. (Recall that Δ_1 is obtained by a π -Lutz twist

inside a tight ball B^3 . The boundary of B still has a tight neighborhood after the π -Lutz twist.)

We may also assume that D' is convex since we may stabilize δ'_2 . If the dividing set of D' contains a closed component, then by Theorem 2.14 every neighborhood of D' contains an overtwisted disc which is disjoint from Δ_2 . If D' has a tight neighborhood, then by Proposition 2.7 there is a contact isotopy supported in a small neighborhood of D' which moves a ball B' containing D' into $V = B^3 \cup V'$ and preserves $\Delta_2 \setminus B'$ as a set.

This process can be iterated. After finitely many steps we either found an overtwisted disc in the complement of a Legendrian link which is isotopic to $\Delta_1 \cup \Delta_2$, or we have isotoped Δ_2 into the union of B^3 with a tight tubular neighborhood of ∂B^3 . \square

4.2. Chekanov's theorem on $\pi_0(\text{Diff}_+(S^3, \xi))$ for overtwisted contact structures ξ . The following theorem is stated in Remark 4.15 of [EIF98]. It is attributed to Y. Chekanov without an indication of a proof.

Theorem 4.4 (Chekanov). *Let ξ be an overtwisted oriented contact structure on S^3 and $\text{Diff}_+(S^3, \xi)$ the group of diffeomorphisms of S^3 which preserve ξ and its orientation. Then*

$$\pi_0(\text{Diff}_+(S^3, \xi)) \simeq \begin{cases} \mathbb{Z}_2 \oplus \mathbb{Z}_2 & \text{if } \xi \simeq \xi_{-1} \\ \mathbb{Z}_2 & \text{otherwise.} \end{cases}$$

Proof. According to [Dy01] the homomorphism

$$d : \text{Diff}_+(S^3, \xi) \longrightarrow \mathbb{Z}_2$$

which was described at the end of Section 2.6 is onto for all overtwisted contact structures on S^3 .

We first assume $\xi \simeq \xi_{-1}$. Let $K \subset S^3$ be a non-loose Legendrian unknot with $\text{tb}(K) = 1$. According to Theorem 3.10 and Theorem 3.12 there is a well-defined group homomorphism

$$(14) \quad \begin{aligned} \kappa : \text{Diff}_+(S^3, \xi) &\longrightarrow \mathbb{Z}_2 \\ \psi &\longmapsto \begin{cases} 0 & \text{if } \psi(K) \text{ is Legendrian isotopic to } K \\ 1 & \text{if } \psi(K) \text{ is Legendrian isotopic to } \overline{K}. \end{cases} \end{aligned}$$

By Lemma 3.9, there is an orientation preserving contact diffeomorphism ψ such that $d(\psi) \neq 0$ which maps K to itself but reverses its orientation. Moreover, when one applies the proof of surjectivity of d to the ball surrounding one of the overtwisted discs shown in Figure 4 (as indicated in Remark 2.38), then the resulting contact diffeomorphism φ satisfies $d(\varphi) = 1$ and φ preserves the overtwisted disc up to isotopy.

As we have shown above, a contact diffeomorphism of ξ_{-1} which reverses to orientation of the non-loose unknot interchanges (up to contact isotopy) the two overtwisted discs in Figure 4. This is true because the positive stabilization of the standard non-loose Legendrian unknot yields one of the overtwisted discs in Figure 4 while the negative stabilization (i.e. the positive stabilization when the orientation of K is reversed) yields the other overtwisted disc. Since φ preserves one of the two overtwisted discs in Figure 4 and these two overtwisted discs are not isotopic, $\varphi(K)$ is isotopic to K as oriented knot. Thus, (d, κ) is a surjective

homomorphism

$$(d, \kappa) : \text{Diff}_+(S^3, \xi_{-1}) \longrightarrow \mathbb{Z}_2 \oplus \mathbb{Z}_2.$$

Every orientation preserving contact diffeomorphism ψ in the kernel of this map is isotopic to the identity inside of $\text{Diff}_+(S^3, \xi_{-1})$ by Corollary 3.19. This finishes the proof of the theorem in the case when $\xi \simeq \xi_{-1}$.

We now consider the case $\xi \not\simeq \xi_{-1}$. Let ψ be a contact diffeomorphism of (S^3, ξ) which preserves the orientation of ξ and $d(\psi) = 0$ and choose an overtwisted disc D . By Theorem 4.3 the complement of $\partial D \cup \psi(\partial D)$ is overtwisted. Therefore, we may assume that ψ preserves an overtwisted disc and since $d(\psi)$ is trivial we can apply Theorem 2.5 to obtain an isotopy connecting ψ to the identity. \square

The following consequence is immediate. We denote the connected component of the space of contact structure on S^3 which contains a fixed contact structure ξ by $\text{Cont}(S^3, \xi)$.

Corollary 4.5. *Let ξ be an overtwisted contact structure on S^3 . Then*

$$\pi_1(\text{Cont}(S^3, \xi)) \simeq \begin{cases} \mathbb{Z}_2 \oplus \mathbb{Z}_2 & \text{if } \xi \simeq \xi_{-1} \\ \mathbb{Z}_2 & \text{otherwise.} \end{cases}$$

Proof. This follows from the long exact sequence of the fibration

$$\text{Diff}_+(S^3, \xi) \longrightarrow \text{Diff}(S^3, \text{or}) \longrightarrow \text{Cont}(S^3, \xi).$$

One can choose ξ to be invariant under rotations around one complex plane in $\mathbb{C}^2 \supset S^3$. This shows that the map $\pi_1(\text{Diff}(S^3, \text{or})) \simeq \pi_1(\text{SO}(4)) \longrightarrow \pi_1(\text{Cont}(S^3, \xi))$ is trivial. \square

4.3. Completion of the classification of Legendrian unknots in overtwisted contact structures on S^3 . As final application of the classification of minimal non-loose unknots and of Theorem 4.4 we complete the classification of Legendrian unknots in S^3 . First, we consider the contact structure ξ_{-1} and non-loose unknots, after that we consider the loose case.

We already know the coarse classification for non-loose unknots: If $K \subset (S^3, \xi)$ is a non-loose unknot, then

$$\text{tb}(K) = n > 0 \qquad \text{rot}(K) = \pm(n - 1),$$

and there is an orientation preserving contact diffeomorphism mapping K to $K_{n,1}$, respectively $K_{-n,-1}$, if $\text{rot}(K) = n - 1$, respectively $\text{rot}(K) = -(n - 1)$. Let us consider the first case. We know two examples of knots with the same classical invariants as K , namely $K_{n,1}$ and $K_{-1,-n}$.

Furthermore, we have explained (Figure 6) that after $n-1$ negative stabilizations of $K_{1,n}$, respectively $K_{-1,-n}$, we end up with $K_{1,1}$, respectively $K_{-1,-1}$. These two knots are not Legendrian isotopic by Theorem 3.12. Therefore, $K_{n,1}$ is not isotopic to $K_{-1,-n}$.

Theorem 4.6. *Let $K \subset S^3$ be a non-loose Legendrian unknot with $\text{tb}(K) = n > 0$ and $\text{rot}(K) = n - 1$. Then K is isotopic to either $K_{n,1}$ or $K_{-1,-n}$.*

Proof. By Chekanov's theorem and the coarse classification of non-loose unknots, K is isotopic to one of the following knots:

$$K_{n,1} \quad \psi(K_{n,1}) = K_{-1,-n} \quad \varphi(K_{n,1}) \quad \varphi(\psi(K_{n,1})),$$

where ψ is the contactomorphism from Example 2.33 and φ is a contactomorphism with $d(\varphi) = 1$ and $\kappa(\varphi) = 0$. We already know that $K_{n,1}$ and $K_{-1,-n}$ are not isotopic. Therefore it suffices to show that $\varphi(K_{n,1})$ is isotopic to $K_{n,1}$.

We may assume that φ preserves $K_{1,1}$ together with a tubular neighborhood N_0 of $K_{1,1}$ pointwise. The claim follows if we show that $K_{n,1}$ is isotopic to a knot contained in N_0 .

Now $K_{n,1}$ can be obtained from $K_{1,1}$ by a $(n-1)$ -fold band connected sum with $K_{1,0}$. The $(n-1)$ copies of $K_{1,0}$ are unlinked copies of the boundary of an overtwisted disc (as in Figure 21).

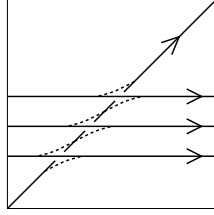

FIGURE 21. Obtaining $K_{4,1}$ from $K_{1,1}$ and three copies of $L_{1,0}$

This collection of $n-1$ unknots is Legendrian isotopic to a Legendrian link contained in N_0 . But this is clear since a negative stabilization of $K_{1,1}$ (the stabilization is contained N_0) is isotopic to $K_{1,0}$. We have seen in Figure 6 that this isotopy can be chosen so that it does not move $K_{1,1}$ nor the region where the band connected sum is performed. \square

Again relying on Theorem 4.4 we now give a complete classification of loose unknots in (S^3, ξ) up to isotopy. Recall that Eliashberg and Fraser showed in [EIF09] that two Legendrian unknots K_1, K_2 in an overtwisted contact structure are isotopic when

$$\text{tb}(K_1) = \text{tb}(K_2) < 0 \quad \text{rot}(K_1) = \text{rot}(K_2).$$

This is complemented by the following proposition. Before we state it, we fix $\psi \in \text{Diff}_+(S^3, \xi_{-1})$ with $\kappa(\psi) \neq 0$.

Proposition 4.7. *Let K be a loose Legendrian unknot with $\text{tb}(K) \geq 0$ in (S^3, ξ_{-1}) . Every other loose Legendrian unknot $L \subset (S^3, \xi_{-1})$ with the same classical invariants is Legendrian isotopic to either K or $\psi(K)$*

Proof. Because L and K are loose, one can use Theorem 2.5 directly to construct a contact diffeomorphism φ preserving the orientation of ξ such that $\varphi(K) = L$. When $d(\varphi) \neq 0$ then we compose φ with a contact diffeomorphism from Remark 2.38, so we may assume $d(\varphi) = 0$.

By Theorem 4.4 φ is either isotopic to the identity or to ψ . Hence, L is isotopic to K or $\psi(K)$. What remains to be shown is that $\psi(K)$ and K are not Legendrian isotopic.

For this, we first assume that $\text{tb}(K) = 0$. If in addition $\text{rot}(K) = r = \pm 1$, then the claim follows from Theorem 3.18. We assume that $r \geq 3$ (recall that the sum of the Thurston-Bennequin invariant and the rotation number of a null-homologous knot is odd).

According to Proposition 3.1 in [Ho] there is a convex disc D with $\partial D = K$. Moreover, $\text{rot}(D) = \chi(D_+) - \chi(D_-)$ by (4) on p. 9 when D is a convex surface with contact vector field X transverse to D such that X , respectively $-X$, coorients ξ on the interior of D_+ , respectively D_- .

If $r \geq 3$, then $\chi(D_+) \geq 2$. By the Legendrian realization principle (Theorem 3.7 in [Ho]) we may assume that there is a properly embedded Legendrian arc $\gamma_D \subset D$ such that

- all singular points of $\xi(D)$ along γ_D and ∂D have the same sign, and
- there is a segment $\sigma_D \subset \partial D$ such that $\gamma_D \cup \sigma_D$ is a piecewise smooth Legendrian knot with $\text{rot}(\gamma_D \cup \sigma_D) = 1$ (we use the orientation of σ_D to orient $\gamma_D \cup \sigma_D$) and $\text{tb}(\gamma_D \cup \sigma_D) = 0$.

Now assume that $\psi(K)$ and K are isotopic through Legendrian knots K_t . We obtain a contact isotopy φ_t such that $\varphi_0 = \text{id}$, $\varphi_t(K) = K_t$ and $\varphi_1(\sigma_D) = \psi(\sigma_D)$. However, $\varphi_1(D) = \widehat{D}$ and $\psi(D)$ do not coincide in general.

There is a smooth isotopy $\widehat{\varphi}_t$ such that $\widehat{\varphi}_0 = \text{id}$ and $\widehat{\varphi}_1(\widehat{D}) = \psi(D)$ fixing $\psi(K)$. Moreover, we may assume that the isotopy is the identity on a ball B_t which is disjoint from the interior of $\widehat{\varphi}_t(\widehat{D})$ and contains $\psi(K)$ in its boundary. This determines a family of contact structures $\widehat{\xi}_t = (\widehat{\varphi}_t)_*(\xi_{-1})$ such that $\widehat{\xi}_t = \xi_{-1}$ on B_t . The restriction of ξ_{-1} to B_t is overtwisted since $\text{tb}(\psi(K)) = 0$. By Remark 2.38 we may assume that the loop $\widehat{\xi}_t$ of contact structures is trivial as a loop of plane fields.

By Theorem 2.5 and the discussion following this statement $\widehat{\xi}_t$ is trivial as a loop of contact structures. Using Gray's theorem we can deform the isotopy $\widehat{\varphi}_t$ to a contact isotopy $\widetilde{\varphi}_t$ of (S^3, ξ_{-1}) such that $\widetilde{\varphi}_0 = \widehat{\varphi}_0$ and $\widetilde{\varphi}_1 = \widehat{\varphi}_1$.

We have constructed a contact isotopy which moves D to $\psi(D)$. But this implies that $\gamma_D \cup \sigma_D$ and $\psi(\gamma_D \cup \sigma_D)$ are Legendrian isotopic. This is a contradiction to Theorem 3.18. Hence, K cannot be isotopic to $\psi(K)$ when $\text{tb}(K) = 0$.

Finally, if $\text{tb}(K) > 0$, then every isotopy interpolating between K and $\psi(K)$ induces an isotopy interpolating between the $\text{tb}(K)$ -fold positive stabilization of K and its image under ψ . This is a contradiction to what we have already shown. \square

Finally, let ξ be an overtwisted contact structure which is not isomorphic to ξ_{-1} .

Proposition 4.8. *Legendrian unknots in (S^3, ξ) are classified up to Legendrian isotopy by the Thurston-Bennequin invariant and the rotation number.*

Proof. Let K, K' be two Legendrian unknots with the same Thurston-Bennequin invariant and rotation number. Both unknots are loose by Theorem 3.2, we fix an overtwisted disc which is disjoint from K . There is a diffeomorphism ψ of ξ which maps K to K' . If $d(\psi) = 0$, then ψ is isotopic to the identity through contact diffeomorphisms. If $d(\psi) \neq 0$, then we precompose ψ with a contact diffeomorphism φ which is supported in a neighborhood of D and satisfies $d(\varphi) = 1$. \square

REFERENCES

- [BaO] K. L. Baker, S. Onaran, *Non-looseness of non-loose knots*, Alg. & Geom. Topology, (2015) Vol. 15, No. 2, 1031–1066.
- [Be] D. Bennequin, *Entrelacements et équations de Pfaff*, Astérisque 107–108 (1983), 83–161.
- [Ce] J. Cerf, *Sur les difféomorphismes de la sphère de dimension trois ($\Gamma_4 = 0$)*, Lect. Notes in Math. 53 (1968), Springer.

- [Co97] V. Colin, *Chirurgies d'indice un et isotopies de sphères dans les variétés de contact tendues*, C. R. Acad. Sci. Paris Sér. I Math. 324 (1997), no. 6, 659–663.
- [Co99] V. Colin, *Recollement des variétés de contact tendues*, Bull. Soc. math. France 127 (1999), 43–96.
- [DFN] B. Dubrovin, A. Fomenko, S. Novikov, *Modern Geometry - Methods and Applications – Part II*, Grad. Texts in Math. 104, Springer 1985.
- [Dy01] K. Dymara, *Legendrian knots in overtwisted contact structures on S^3* , Ann. Global Anal. Geom. 19 (2001), no. 3, 293–305.
- [Dy04] K. Dymara, *Legendrian knots in overtwisted contact structures*, arxiv:math/0410122v2.
- [El89] Y. Eliashberg, *Classification of overtwisted contact structures on 3-manifolds*, Invent. Math. 98 (1989), 623–637.
- [El92] Y. Eliashberg, *Contact 3-manifolds twenty years since J. Martinet's work*, Ann. Inst. Fourier 42, 1–2 (1992), 165–192.
- [EIF98] Y. Eliashberg, M. Fraser, *Classification of topologically trivial Legendrian knots*, Geometry, topology, and dynamics 17–51, CRM Proc. Lecture Notes, 15, Amer. Math. Soc., Providence, RI, 1998.
- [EIF09] Y. Eliashberg, M. Fraser, *Topologically trivial Legendrian knots*, J. Symplectic Geom. 7 (2009), no. 2, 77–127.
- [EtN] J. Etnyre, L. Ng, *Problems in low dimensional contact geometry*, Topology and Geometry of Manifolds, Proc. Sympos. Pure Math. 71 (2003), 337–357.
- [Et05] J. Etnyre, *Legendrian and Transversal Knots*, Handbook of Knot Theory (Elsevier B. V., Amsterdam), 2005, 105–185.
- [Et08] J. Etnyre, *On contact surgery*, Proc. Amer. Math. Soc. 136 (2008), no. 9, 3355–3362.
- [Et13] J. Etnyre, *On knots in overtwisted contact structures*, Quantum Topol. 4 (2013), no. 3, 229–264.
- [Ey] H. Eynard-Bontemps, *On the connectedness of the space of codimension one foliations on a closed 3-manifold*, Invent. Math. 204 (2016), no. 2, 605–670.
- [Ge] H. Geiges, *An introduction to contact topology*, Cambridge Studies in Advanced Mathematics, 109. Cambridge University Press, Cambridge, 2008.
- [GeO] H. Geiges, S. Onaran, *Legendrian rational unknots in lens spaces*, J. of Symplectic Geom. 13 (2015), no. 1, 17–50.
- [Gi91] E. Giroux, *Convexité en topologie de contact*, Comment. Math. Helv. 66 (1991), no. 4, 637–677.
- [Gi93] E. Giroux, *Topologie de contact en dimension 3 (autour des travaux de Yakov Eliashberg)*, Séminaire Bourbaki, Vol. 1992/93, Astérisque No. 216 (1993), Exp. No. 760, 3, 7–33.
- [Gi00] E. Giroux, *Structures de contact en dimension trois et bifurcations des feuilletages de surfaces*, Invent. Math. 141 (2000), no. 3, 615–689.
- [Ha81] A. Hatcher, *On the diffeomorphism group of $S^1 \times S^2$* , Proc. Amer. Math. Soc. 83 (1981), no. 2, 427–430.
- [Ha83] A. Hatcher, *A proof of the Smale conjecture*, $\text{Diff}(S^3) \simeq \text{O}(4)$, Ann. of Math. (2) 117 (1983), no. 3, 553–607.
- [Ha01] A. Hatcher, *Algebraic topology*, Cambridge University Press 2001.
- [Hi] M. W. Hirsch, *Differential topology*, Graduate Texts in Math. 33, Springer 1997.
- [Ho] K. Honda, *On the classification of tight contact structures. I*, Geometry & Topology 4 (2000), 309–368.
- [H] H. Hopf, *Über die Abbildungen der dreidimensionalen Sphäre auf die Kugelfläche*, Math. Ann. 104 (1931), 637–665.
- [Hu13] Y. Huang, *A proof of the classification theorem of overtwisted contact structures via convex surface theory*, J. Symplectic Geom. 11 (2013), no. 4, 563–601.
- [Hu14] Y. Huang, *Bypass attachments and homotopy classes of 2-plane fields in contact topology*, J. Symplectic Geom. 12 (2014), no. 3, 599–617.
- [LOSS] P. Lisca, P. Ozsváth, A. Stipsicz, Z. Szabó, *Heegaard Floer invariants of Legendrian knots in contact three-manifolds*, J. Eur. Math. Soc. 11 (2009), no. 6, 1307–1363.
- [Lu] R. Lutz, *Structures de contact sur les fibrés principaux en cercles de dimension trois*, Ann. Inst. Fourier (Grenoble) 27 (1977), no. 3, ix, 1–15.
- [Mi] J. W. Milnor, *Topology from the differentiable viewpoint*, Princeton Landmarks in Math., Princeton University Press, Princeton, NJ, 1997.

- [Ro] R. Roussarie, *Plongements dans les variétés feuilletées et classification de feuilletages sans holonomie*, I.H.E.S. Publ. Math. 423 (1973), 101-142.
- [V] T. Vogel, *On the uniqueness of the contact structure approximating a foliation*, Geometry & Topology 20 (2106), no. 5, 2439–2573.

MATHEMATISCHES INSTITUT, LUDWIG-MAXIMILIANS-UNIVERSITÄT, THERESIENSTR. 39,
80333 MÜNCHEN, GERMANY
E-mail address: tvogel@math.lmu.de